

Western Electric

257A Vacuum Tube

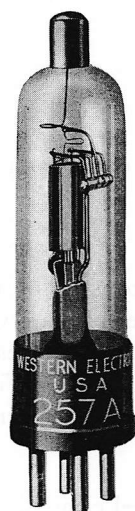

Classification—Small, filamentary triode

The 257A tube is similar to the 231D tube except that the grid terminal of the 257A tube is at the top of the bulb. An important feature of the 257A tube is its low filament power consumption.

Applications

Audio-frequency and intermediate-frequency amplifier.

Detector.

Oscillator.

Dimensions—Outline diagrams showing dimensions of the tube and base, and the arrangement of the electrode connections to the base terminals are given in Figures 1 and 2.

Base—Small, four-pin, thrust base. Small metal cap grid terminal at the top of the bulb. One base contact pin is unconnected.

Socket—Standard four-contact type such as the Western Electric 143B socket.

Mountings Positions—Either vertical or horizontal. If mounted in a horizontal position the plane of the filament, which is indicated in Figure 2, should be vertical.

Average Direct Interelectrode Capacitances

Grid to plate	3.0 $\mu\text{mf.}$
Grid to filament	1.8 $\mu\text{mf.}$
Plate to filament	2.3 $\mu\text{mf.}$

Filament Rating

Filament current	0.060 ampere, d.c.
Nominal filament voltage	3.1 volts

The filament of this tube is designed to operate on a current basis and should be operated at as near the rated current as is practicable.

Characteristics—Plate current characteristics of a typical 257A tube are shown in Figure 3 as functions of grid voltage for several values of plate voltage. The grid and plate voltages are measured from the negative end of the filament. Corresponding amplification factor, plate resistance, and transconductance characteristics are given in Figures 4, 5 and 6, respectively. Plate current characteristics as functions of plate voltage are shown in Figure 7 for several values of grid voltage.

Operating Conditions and Output—Permissible operating plate and grid voltages are included within the area, ABCD, in Figure 3. Amplification factor, plate resistance, transconductance, and performance data are given in the table on page 3 for a number of typical operating conditions represented by selected points within this area. The less severe operating conditions should be selected in preference to maximum operating conditions wherever possible. The life of the tube at maximum conditions may be shorter than at less severe conditions.

The performance data include the fundamental power or voltage output and the second and third harmonic levels for the indicated values of load resistance. The fundamental output is given in terms of the power, P_m , in milliwatts for values of load resistance, R , equal to and double the value of the plate resistance, r_p , and in terms of the voltage, E_{pm} , in peak volts for values of load resistance five times the plate resistance. The second and third harmonic levels, F_{2m} and F_{3m} , are given in decibels below the fundamental in each case. The peak value of the sinusoidal input voltage, E_{gm} , is numerically equal to the grid bias for each operating condition. For a smaller input voltage, E_g , the fundamental power and voltage output and the harmonic levels are given approximately by the following relations:

$$P = P_m \left(\frac{E_g}{E_{gm}} \right)^2$$

$$E_p = E_{pm} \frac{E_g}{E_{gm}}$$

$$F_2 = F_{2m} + 20 \log_{10} \frac{E_{gm}}{E_g}$$

$$F_3 = F_{3m} + 40 \log_{10} \frac{E_{gm}}{E_g}$$

TABLE

Plate Voltage	Grid Bias	Plate Current	Amplification Factor	Plate Resistance	Transconductance	Input Voltage	Load Resistance	Power Output	Voltage Output	Second Harmonic	Third Harmonic
Volts	Volts	Milli-amperes		Ohms r_p	Micro-mhos	Peak Volts	R	Milli-watts	Peak Volts	db	db
67.5	-3.0	.93	8.5	22500	380	3.0	$R = r_p$	3.0	20	29	50
							$R = 2r_p$	2.5		36	60
							$R = 5r_p$			47	70
67.5	-1.5	1.55	8.5	18300	460	1.5	$R = r_p$	1.0		39	70
							$R = 2r_p$	0.9	46	80	
90.0	-5.0	1.15	8.5	20700	410	5.0	$R = r_p$	10	35	26	43
							$R = 2r_p$	9		33	50
							$R = 5r_p$			42	65
90.0	-3.0	2.10	8.4	16300	510	3.0	$R = r_p$	4.5	22	36	60
							$R = 2r_p$	4.0		42	70
							$R = 5r_p$			50	75
112.5	-8.0	1.00	8.5	22200	390	8.0	$R = r_p$	23	55	21	34
							$R = 2r_p$	20		27	42
							$R = 5r_p$			38	60
112.5	-6.0	1.90	8.4	17200	490	6.0	$R = r_p$	17	42	29	45
							$R = 2r_p$	15		35	55
							$R = 5r_p$			44	70
135.0	-11.5	0.70	8.5	27000	320	11.5	$R = r_p$	45	76	17	28
							$R = 2r_p$	50		23	34
							$R = 5r_p$			33	47
135.0	-10.0	1.25	8.5	20300	420	10.0	$R = r_p$	40	67	21	32
							$R = 2r_p$	35		28	41
							$R = 5r_p$			37	55
135.0	-8.5	1.95	8.5	17200	490	8.5	$R = r_p$	35	57	26	40
							$R = 2r_p$	30		33	50
							$R = 5r_p$			42	65
*90.0	-1.5	2.90	8.4	14500	580	1.5	$R = r_p$	1.2		46	75
							$R = 2r_p$	1.0		50	85
*112.5	-4.5	2.65	8.4	15000	560	4.5	$R = r_p$	10	30	34	55
							$R = 2r_p$	9		40	65
							$R = 5r_p$			50	70
*135.0	-7.5	2.50	8.4	15600	540	7.5	$R = r_p$	27	48	29	47
							$R = 2r_p$	24		36	55
							$R = 5r_p$			45	70

*Maximum operating conditions.

Microphonic Noise—With a plate voltage of 90 volts, a grid bias of -3 volts, and a load resistance of 100,000 ohms, the mean microphonic noise output level of the 257A tube measured in a laboratory reference test set, is 22 decibels below 1 volt. The range of levels of individual tubes extends from 12 to 36 decibels. Since microphonic noise depends on the type and intensity of the mechanical disturbance which produces it, the values given here are useful chiefly for comparison with the levels of other tubes which have been tested in the same way.

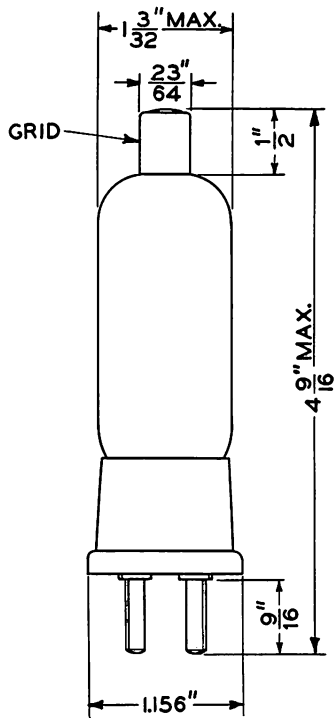

FIG. 1

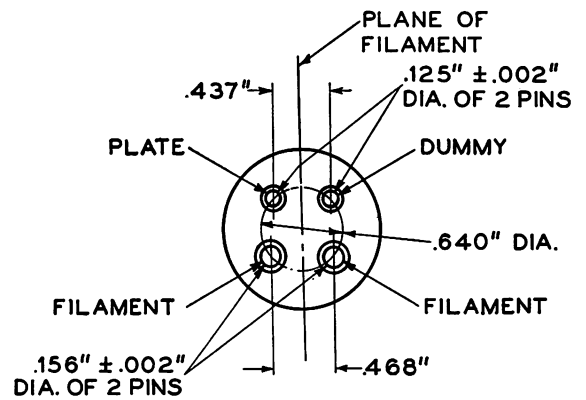

FIG. 2

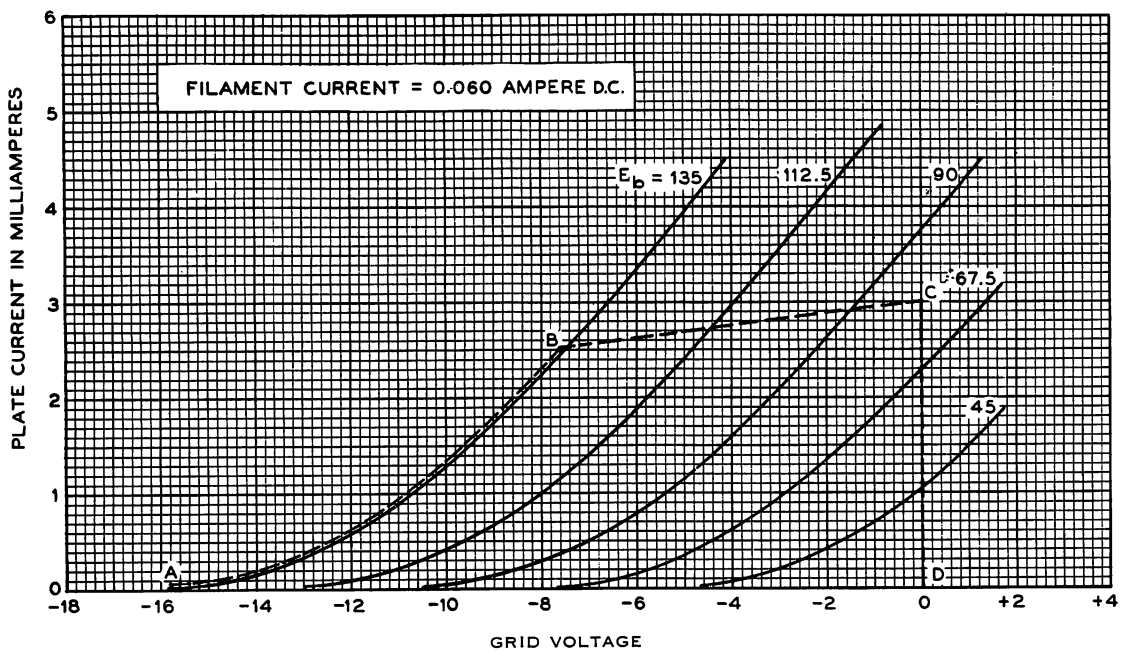

FIG. 3

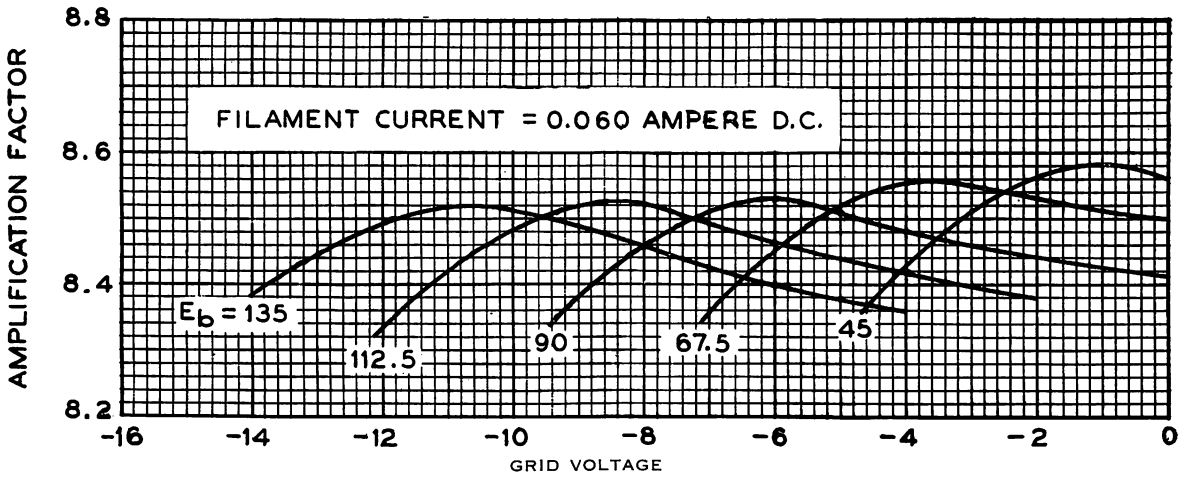

FIG. 4

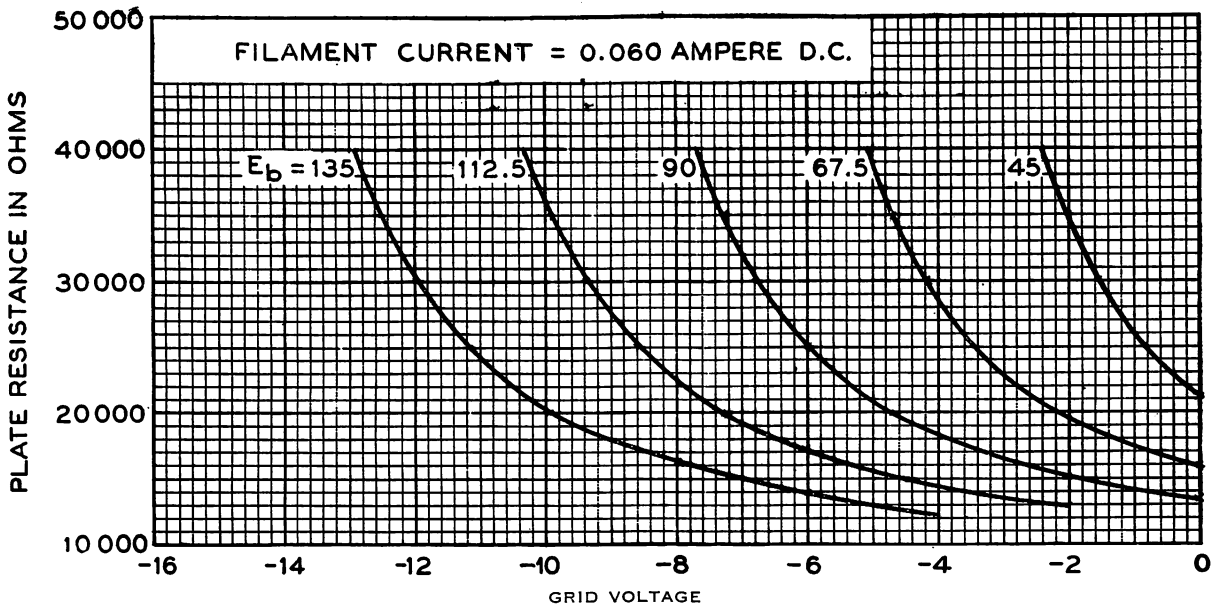

FIG. 5

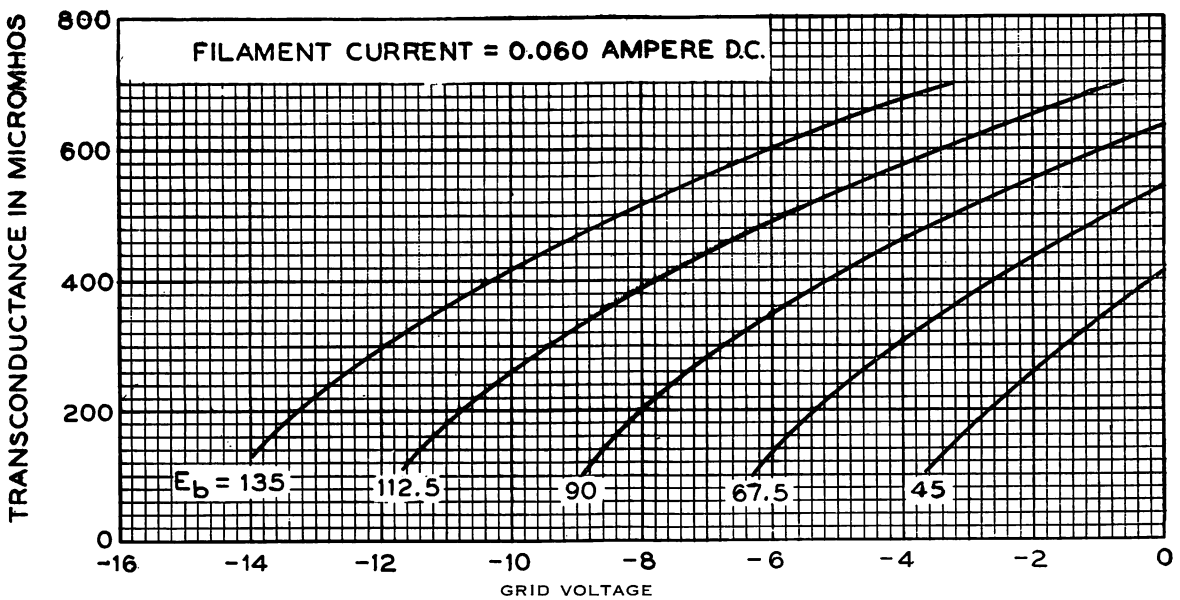

FIG. 6

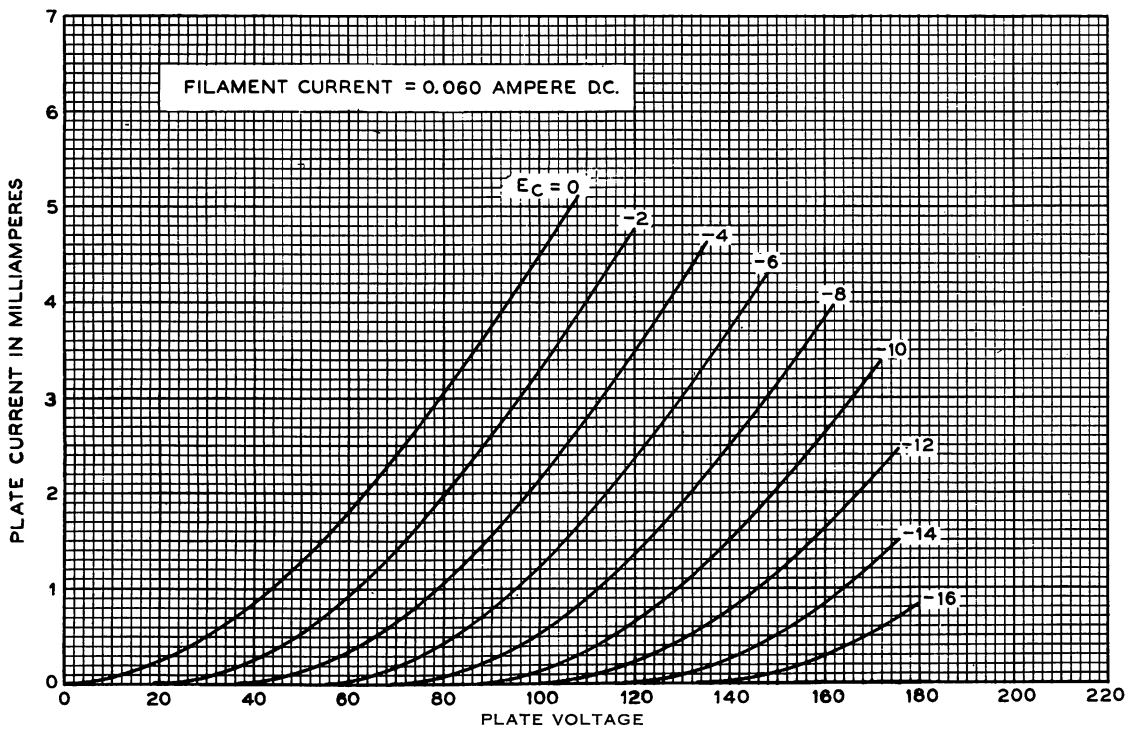

FIG. 7