

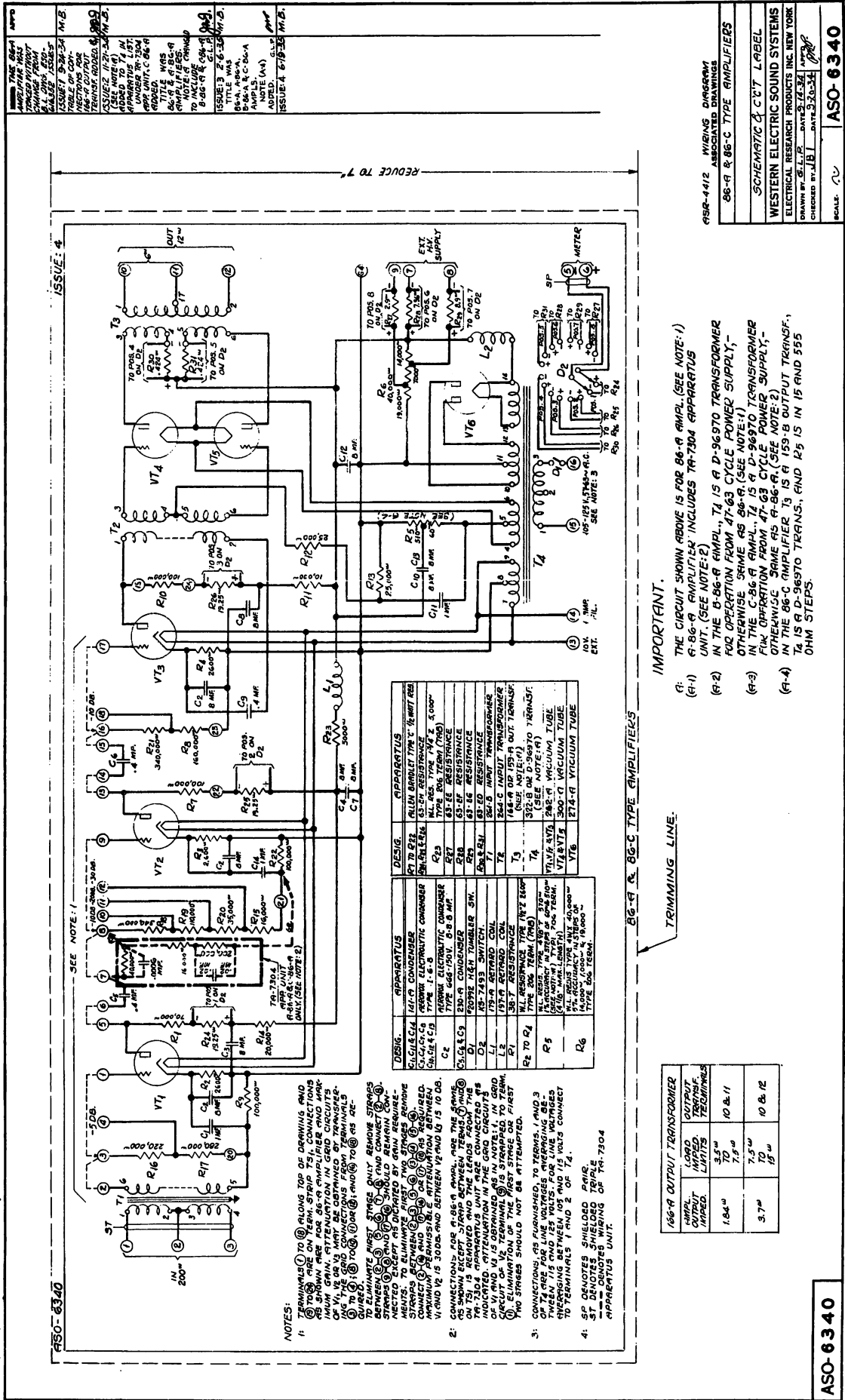

4.03  
ASO-6340-4, Assoc. with Amplifiers, 66 Type



IMPORTANT.

(1) THE CIRCUIT SHOWN ABOVE IS FOR 66-A AMP. (SEE NOTE-1)

(1-1) 66-A AMP. UNIT. (SEE NOTE-2)

(1-2) IN THE 86-A AMP. UNIT. (SEE NOTE-1)

(1-3) FOR OPERATION FROM 47-63 CYCLE POWER SUPPLY, - OTHERWISE SAME AS 86-A. (SEE NOTE-1)

(1-4) IN THE C-86-A AMP. UNIT. (SEE NOTE-1)

(2) IN THE C-86-A AMP. UNIT. (SEE NOTE-1)

(2-1) FOR OPERATION FROM 47-63 CYCLE POWER SUPPLY, - OTHERWISE SAME AS 86-A. (SEE NOTE-2)

(2-2) IN THE 86-C AMP. UNIT. (SEE NOTE-1)

(2-3) IN THE 86-C AMP. UNIT. (SEE NOTE-1)

(2-4) IN THE 86-C AMP. UNIT. (SEE NOTE-1)

TRIMMING LINE.

166-A OUTPUT TRANSFORMER	OUTPUT	TRIMMING
IMPED.	LIMITS	TERMINALS
1.64 $\omega$	3.5 $\omega$	10 & 11
3.7 $\omega$	7.5 $\omega$	10 & 12

NOTES:

1: TERMINALS ① TO ⑥ ALONG TOP OF DRAWING AND ⑦ TO ⑩ ON TERM. STRIP T51. CONNECTIONS AS SHOWN ARE FOR 66-A AMP. UNIT. CONNECTIONS OF V1, V2 OR V3 MAY BE OBTAINED BY TRANSFERRING THE GROUND CONNECTIONS FROM TERMINALS ① TO ②, ③ TO ④, ⑤ TO ⑥ OR ⑦ TO ⑧. TO ELIMINATE FIRST STAGE ONLY REMOVE STRIPS ① AND ② FROM TERMINAL STRIP T51. TO ELIMINATE SECOND STAGE ONLY REMOVE STRIPS ③ AND ④ FROM TERMINAL STRIP T51. TO ELIMINATE BOTH STAGES REMOVE STRIPS ①, ②, ③ AND ④ FROM TERMINAL STRIP T51. CONNECTIONS TO BE MADE AS SHOWN IN DRAWING. CONNECTIONS TO BE MADE AS SHOWN IN DRAWING. CONNECTIONS TO BE MADE AS SHOWN IN DRAWING.

2: CONNECTIONS FOR 66-A AMP. UNIT. ARE THE SAME AS SHOWN IN DRAWING. CONNECTIONS TO BE MADE AS SHOWN IN DRAWING. CONNECTIONS TO BE MADE AS SHOWN IN DRAWING.

3: CONNECTIONS AS FURNISHED TO TERMS. 1 AND 3 TO TERMS 1 AND 3 AND 125 VOLTS. FOR LINE VOLTAGES EXCEEDING BETWEEN 105 AND 125 VOLTS CONNECT TO TERMINALS 1 AND 2 OR 1 & 4.

4: SP DENOTES SHIELDED PAIR. WIRING TO BE DONE AS SHOWN IN DRAWING OF T5. T504 APPARATUS UNIT.

ASO-6340  
APPARATUS  
TITLE WAS  
ISSUE 1  
ISSUE 2  
ISSUE 3  
ISSUE 4  
ISSUE 5  
ISSUE 6  
ISSUE 7  
ISSUE 8  
ISSUE 9  
ISSUE 10  
ISSUE 11  
ISSUE 12  
ISSUE 13  
ISSUE 14  
ISSUE 15  
ISSUE 16  
ISSUE 17  
ISSUE 18  
ISSUE 19  
ISSUE 20  
ISSUE 21  
ISSUE 22  
ISSUE 23  
ISSUE 24  
ISSUE 25  
ISSUE 26  
ISSUE 27  
ISSUE 28  
ISSUE 29  
ISSUE 30  
ISSUE 31  
ISSUE 32  
ISSUE 33  
ISSUE 34  
ISSUE 35  
ISSUE 36  
ISSUE 37  
ISSUE 38  
ISSUE 39  
ISSUE 40  
ISSUE 41  
ISSUE 42  
ISSUE 43  
ISSUE 44  
ISSUE 45  
ISSUE 46  
ISSUE 47  
ISSUE 48  
ISSUE 49  
ISSUE 50  
ISSUE 51  
ISSUE 52  
ISSUE 53  
ISSUE 54  
ISSUE 55  
ISSUE 56  
ISSUE 57  
ISSUE 58  
ISSUE 59  
ISSUE 60  
ISSUE 61  
ISSUE 62  
ISSUE 63  
ISSUE 64  
ISSUE 65  
ISSUE 66  
ISSUE 67  
ISSUE 68  
ISSUE 69  
ISSUE 70  
ISSUE 71  
ISSUE 72  
ISSUE 73  
ISSUE 74  
ISSUE 75  
ISSUE 76  
ISSUE 77  
ISSUE 78  
ISSUE 79  
ISSUE 80  
ISSUE 81  
ISSUE 82  
ISSUE 83  
ISSUE 84  
ISSUE 85  
ISSUE 86  
ISSUE 87  
ISSUE 88  
ISSUE 89  
ISSUE 90  
ISSUE 91  
ISSUE 92  
ISSUE 93  
ISSUE 94  
ISSUE 95  
ISSUE 96  
ISSUE 97  
ISSUE 98  
ISSUE 99  
ISSUE 100

ASO-6340  
APPARATUS  
TITLE WAS  
ISSUE 1  
ISSUE 2  
ISSUE 3  
ISSUE 4  
ISSUE 5  
ISSUE 6  
ISSUE 7  
ISSUE 8  
ISSUE 9  
ISSUE 10  
ISSUE 11  
ISSUE 12  
ISSUE 13  
ISSUE 14  
ISSUE 15  
ISSUE 16  
ISSUE 17  
ISSUE 18  
ISSUE 19  
ISSUE 20  
ISSUE 21  
ISSUE 22  
ISSUE 23  
ISSUE 24  
ISSUE 25  
ISSUE 26  
ISSUE 27  
ISSUE 28  
ISSUE 29  
ISSUE 30  
ISSUE 31  
ISSUE 32  
ISSUE 33  
ISSUE 34  
ISSUE 35  
ISSUE 36  
ISSUE 37  
ISSUE 38  
ISSUE 39  
ISSUE 40  
ISSUE 41  
ISSUE 42  
ISSUE 43  
ISSUE 44  
ISSUE 45  
ISSUE 46  
ISSUE 47  
ISSUE 48  
ISSUE 49  
ISSUE 50  
ISSUE 51  
ISSUE 52  
ISSUE 53  
ISSUE 54  
ISSUE 55  
ISSUE 56  
ISSUE 57  
ISSUE 58  
ISSUE 59  
ISSUE 60  
ISSUE 61  
ISSUE 62  
ISSUE 63  
ISSUE 64  
ISSUE 65  
ISSUE 66  
ISSUE 67  
ISSUE 68  
ISSUE 69  
ISSUE 70  
ISSUE 71  
ISSUE 72  
ISSUE 73  
ISSUE 74  
ISSUE 75  
ISSUE 76  
ISSUE 77  
ISSUE 78  
ISSUE 79  
ISSUE 80  
ISSUE 81  
ISSUE 82  
ISSUE 83  
ISSUE 84  
ISSUE 85  
ISSUE 86  
ISSUE 87  
ISSUE 88  
ISSUE 89  
ISSUE 90  
ISSUE 91  
ISSUE 92  
ISSUE 93  
ISSUE 94  
ISSUE 95  
ISSUE 96  
ISSUE 97  
ISSUE 98  
ISSUE 99  
ISSUE 100



ASR-4412-4, Assoc. with AMPLIFIERS, 66 TYPE  
ISSUE 4

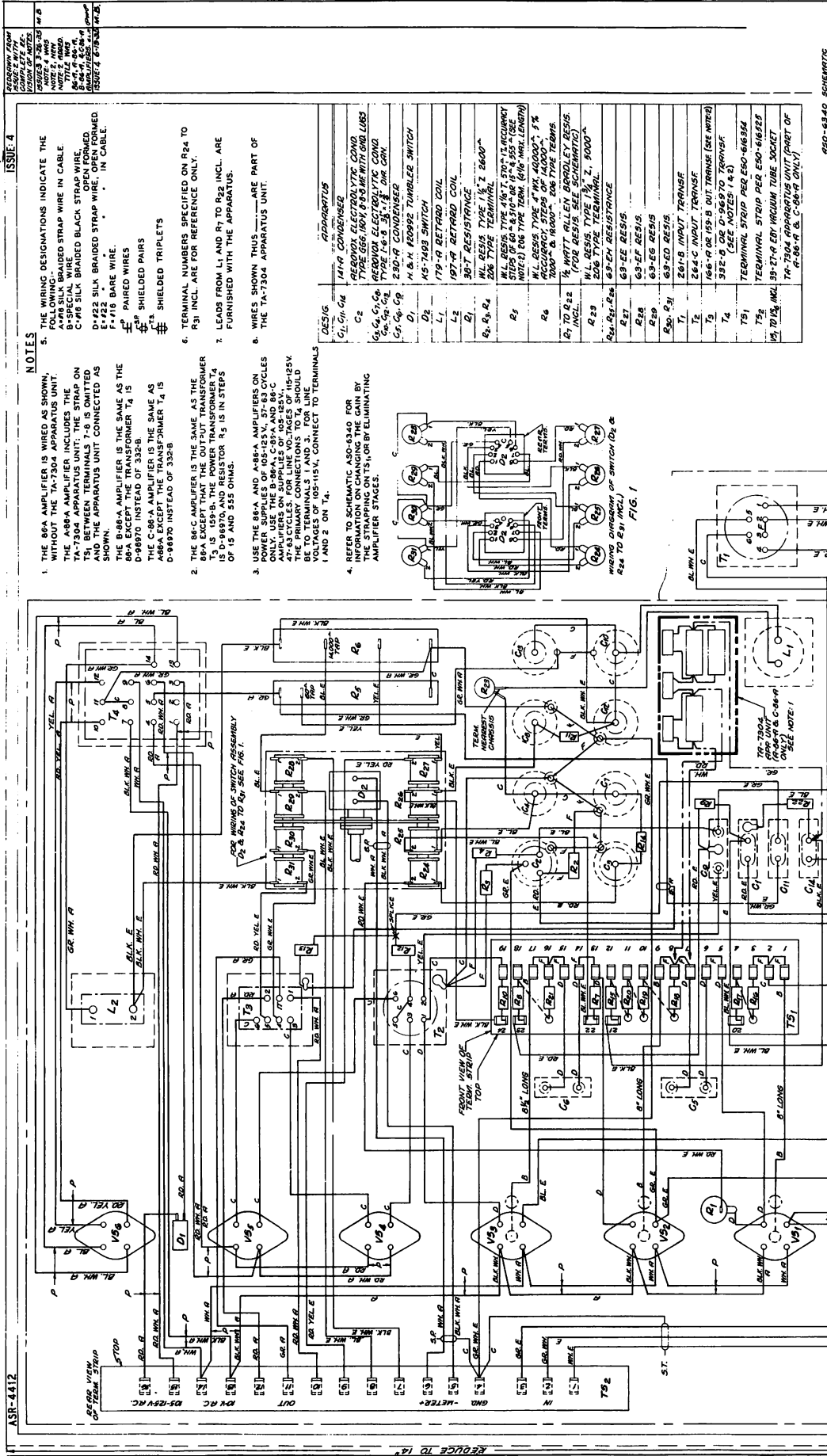

- NOTES**
- THE 86-A AMPLIFIER IS WIRED AS SHOWN, WITHOUT THE TA-7304 APPARATUS UNIT.
  - THE 86-C AMPLIFIER IS THE SAME AS THE 86-A EXCEPT THAT THE OUTPUT TRANSFORMER T<sub>2</sub> IS 150-0-150 B. THE POWER TRANSFORMER T<sub>1</sub> IS D-96970, AND RESISTOR R<sub>5</sub> IS IN STEPS OF 15 AND 335 OHMS.
  - USE THE 86-A AND 86-C AMPLIFIERS ON POWER SUPPLIES OF 105-125 V, 57-63 CYCLES ONLY. USE THE B-86A, C-86A AND 86-C AMPLIFIERS ON POWER SUPPLIES OF 110-120 V, 47-63 CYCLES. FOR LINE VOLTAGES OF 115-125 V, THE PRIMARY CONNECTIONS TO T<sub>1</sub> SHOULD BE MADE TO THE 115 V TAP. FOR LINE VOLTAGES OF 105-115 V, CONNECT TO TERMINALS 1 AND 2 ON T<sub>1</sub>.
  - REFER TO SCHEMATIC ASR-4340 FOR CHANGING THE GAIN BY ADJUSTING THE STRAP ON T<sub>1</sub> BY TERMINATING AMPLIFIER STAGES.

- 5.** THE WIRING DESIGNATIONS INDICATE THE TYPE OF WIRE TO BE USED:
- A#18 SILK BRAIDED STRAP WIRE IN CABLE
  - B-SPECIAL WIRE
  - C-#10 SILK BRAIDED STRAP WIRE, OPEN FORMED
  - D-#22 SILK BRAIDED STRAP WIRE, OPEN FORMED
  - F-#16 BARE WIRE
- 6.** WIRES SHOWN THUS ARE PART OF THE TA-7304 APPARATUS UNIT.

- 7.** LEADS FROM L<sub>1</sub> AND P<sub>1</sub> TO R<sub>22</sub> INCL. ARE FURNISHED WITH THE APPARATUS.
- 8.** WIRES SHOWN THUS ARE PART OF THE TA-7304 APPARATUS UNIT.

- 9.** TERMINAL NUMBERS SPECIFIED ON R<sub>24</sub> TO R<sub>31</sub> INCL. ARE FOR REFERENCE ONLY.
- 10.** THE TA-7304 APPARATUS UNIT IS FURNISHED WITH THE APPARATUS.

- 11.** THE 86-A AND 86-C AMPLIFIERS ON POWER SUPPLIES OF 105-125 V, 57-63 CYCLES ONLY. USE THE B-86A, C-86A AND 86-C AMPLIFIERS ON POWER SUPPLIES OF 110-120 V, 47-63 CYCLES. FOR LINE VOLTAGES OF 115-125 V, THE PRIMARY CONNECTIONS TO T<sub>1</sub> SHOULD BE MADE TO THE 115 V TAP. FOR LINE VOLTAGES OF 105-115 V, CONNECT TO TERMINALS 1 AND 2 ON T<sub>1</sub>.

- 12.** REFER TO SCHEMATIC ASR-4340 FOR CHANGING THE GAIN BY ADJUSTING THE STRAP ON T<sub>1</sub> BY TERMINATING AMPLIFIER STAGES.

**APPARATUS**

DESIG.	DESCRIPTION
C <sub>1</sub> , C <sub>2</sub> , C <sub>3</sub>	14F4 CONDENSER
C <sub>4</sub> , C <sub>5</sub> , C <sub>6</sub>	REOVON ELECTROLYTIC COND. TYPE 669, 150V, 6.8-8.2 MFD WITH GMA LUBS
C <sub>7</sub> , C <sub>8</sub> , C <sub>9</sub>	REOVON ELECTROLYTIC COND. TYPE 1-6-8 3/4, 1/2, DIA. CAN.
C <sub>10</sub> , C <sub>11</sub>	230-19 CONDENSER
D <sub>1</sub>	H. & W. 180992 TUMBLER SWITCH
D <sub>2</sub>	MS-7493 SWITCH
L <sub>1</sub>	179-9 RETARD COIL
L <sub>2</sub>	107-9 RETARD COIL
R <sub>1</sub>	30-T RESISTANCE
R <sub>2</sub> , R <sub>3</sub> , R <sub>4</sub>	WLL RESIS TYPE 1/4, 1/2, 2600
R <sub>5</sub>	WLL RESIS TYPE 4 1/2, 570, 1/4, ACCURACY STEPS OF 60-8, 210-98, 5-8, 555
R <sub>6</sub>	NOTE: 1) FOR THE TERM. (SEE MAX. LENGTH) 2) 200 TYPE TERMINAL
R <sub>7</sub> , R <sub>8</sub> , R <sub>9</sub>	WLL RESIS TYPE 4 1/2, 570, 1/4, ACCURACY STEPS OF 60-8, 210-98, 5-8, 555
R <sub>10</sub> , R <sub>11</sub>	1/4 WATT ALLEN BRADLEY RESIS (FOR RESIS. SEE SCHEMATIC)
R <sub>12</sub>	WLL RESIS TYPE 1/4, 2, 9000
R <sub>13</sub>	200 TYPE TERMINAL
R <sub>14</sub> , R <sub>15</sub> , R <sub>16</sub>	63-EE RESIS
R <sub>17</sub>	63-EE RESIS
R <sub>18</sub>	63-EF RESIS
R <sub>19</sub>	63-EG RESIS
R <sub>20</sub> , R <sub>21</sub>	63-ED RESIS
T <sub>1</sub>	261-B INPUT TRANSF.
T <sub>2</sub>	666-10 (100-0) OUTPUT TRANSF. (SEE NOTE)
T <sub>3</sub>	332-0 (SEE NOTES 1 & 2)
T <sub>4</sub>	TERMINAL STRIP, REG. ESO-616384
T <sub>5</sub>	TERMINAL STRIP, REG. ESO-616384
T <sub>6</sub>	TERMINAL STRIP, REG. ESO-616384
T <sub>7</sub>	TERMINAL STRIP, REG. ESO-616384
T <sub>8</sub>	TERMINAL STRIP, REG. ESO-616384
T <sub>9</sub>	TERMINAL STRIP, REG. ESO-616384
T <sub>10</sub>	TERMINAL STRIP, REG. ESO-616384
T <sub>11</sub>	TERMINAL STRIP, REG. ESO-616384
T <sub>12</sub>	TERMINAL STRIP, REG. ESO-616384
T <sub>13</sub>	TERMINAL STRIP, REG. ESO-616384
T <sub>14</sub>	TERMINAL STRIP, REG. ESO-616384
T <sub>15</sub>	TERMINAL STRIP, REG. ESO-616384
T <sub>16</sub>	TERMINAL STRIP, REG. ESO-616384
T <sub>17</sub>	TERMINAL STRIP, REG. ESO-616384
T <sub>18</sub>	TERMINAL STRIP, REG. ESO-616384
T <sub>19</sub>	TERMINAL STRIP, REG. ESO-616384
T <sub>20</sub>	TERMINAL STRIP, REG. ESO-616384
T <sub>21</sub>	TERMINAL STRIP, REG. ESO-616384
T <sub>22</sub>	TERMINAL STRIP, REG. ESO-616384
T <sub>23</sub>	TERMINAL STRIP, REG. ESO-616384
T <sub>24</sub>	TERMINAL STRIP, REG. ESO-616384
T <sub>25</sub>	TERMINAL STRIP, REG. ESO-616384
T <sub>26</sub>	TERMINAL STRIP, REG. ESO-616384
T <sub>27</sub>	TERMINAL STRIP, REG. ESO-616384
T <sub>28</sub>	TERMINAL STRIP, REG. ESO-616384
T <sub>29</sub>	TERMINAL STRIP, REG. ESO-616384
T <sub>30</sub>	TERMINAL STRIP, REG. ESO-616384
T <sub>31</sub>	TERMINAL STRIP, REG. ESO-616384
T <sub>32</sub>	TERMINAL STRIP, REG. ESO-616384
T <sub>33</sub>	TERMINAL STRIP, REG. ESO-616384
T <sub>34</sub>	TERMINAL STRIP, REG. ESO-616384
T <sub>35</sub>	TERMINAL STRIP, REG. ESO-616384
T <sub>36</sub>	TERMINAL STRIP, REG. ESO-616384
T <sub>37</sub>	TERMINAL STRIP, REG. ESO-616384
T <sub>38</sub>	TERMINAL STRIP, REG. ESO-616384
T <sub>39</sub>	TERMINAL STRIP, REG. ESO-616384
T <sub>40</sub>	TERMINAL STRIP, REG. ESO-616384
T <sub>41</sub>	TERMINAL STRIP, REG. ESO-616384
T <sub>42</sub>	TERMINAL STRIP, REG. ESO-616384
T <sub>43</sub>	TERMINAL STRIP, REG. ESO-616384
T <sub>44</sub>	TERMINAL STRIP, REG. ESO-616384
T <sub>45</sub>	TERMINAL STRIP, REG. ESO-616384
T <sub>46</sub>	TERMINAL STRIP, REG. ESO-616384
T <sub>47</sub>	TERMINAL STRIP, REG. ESO-616384
T <sub>48</sub>	TERMINAL STRIP, REG. ESO-616384
T <sub>49</sub>	TERMINAL STRIP, REG. ESO-616384
T <sub>50</sub>	TERMINAL STRIP, REG. ESO-616384
T <sub>51</sub>	TERMINAL STRIP, REG. ESO-616384
T <sub>52</sub>	TERMINAL STRIP, REG. ESO-616384
T <sub>53</sub>	TERMINAL STRIP, REG. ESO-616384
T <sub>54</sub>	TERMINAL STRIP, REG. ESO-616384
T <sub>55</sub>	TERMINAL STRIP, REG. ESO-616384
T <sub>56</sub>	TERMINAL STRIP, REG. ESO-616384
T <sub>57</sub>	TERMINAL STRIP, REG. ESO-616384
T <sub>58</sub>	TERMINAL STRIP, REG. ESO-616384
T <sub>59</sub>	TERMINAL STRIP, REG. ESO-616384
T <sub>60</sub>	TERMINAL STRIP, REG. ESO-616384
T <sub>61</sub>	TERMINAL STRIP, REG. ESO-616384
T <sub>62</sub>	TERMINAL STRIP, REG. ESO-616384
T <sub>63</sub>	TERMINAL STRIP, REG. ESO-616384
T <sub>64</sub>	TERMINAL STRIP, REG. ESO-616384
T <sub>65</sub>	TERMINAL STRIP, REG. ESO-616384
T <sub>66</sub>	TERMINAL STRIP, REG. ESO-616384
T <sub>67</sub>	TERMINAL STRIP, REG. ESO-616384
T <sub>68</sub>	TERMINAL STRIP, REG. ESO-616384
T <sub>69</sub>	TERMINAL STRIP, REG. ESO-616384
T <sub>70</sub>	TERMINAL STRIP, REG. ESO-616384
T <sub>71</sub>	TERMINAL STRIP, REG. ESO-616384
T <sub>72</sub>	TERMINAL STRIP, REG. ESO-616384
T <sub>73</sub>	TERMINAL STRIP, REG. ESO-616384
T <sub>74</sub>	TERMINAL STRIP, REG. ESO-616384
T <sub>75</sub>	TERMINAL STRIP, REG. ESO-616384
T <sub>76</sub>	TERMINAL STRIP, REG. ESO-616384
T <sub>77</sub>	TERMINAL STRIP, REG. ESO-616384
T <sub>78</sub>	TERMINAL STRIP, REG. ESO-616384
T <sub>79</sub>	TERMINAL STRIP, REG. ESO-616384
T <sub>80</sub>	TERMINAL STRIP, REG. ESO-616384
T <sub>81</sub>	TERMINAL STRIP, REG. ESO-616384
T <sub>82</sub>	TERMINAL STRIP, REG. ESO-616384
T <sub>83</sub>	TERMINAL STRIP, REG. ESO-616384
T <sub>84</sub>	TERMINAL STRIP, REG. ESO-616384
T <sub>85</sub>	TERMINAL STRIP, REG. ESO-616384
T <sub>86</sub>	TERMINAL STRIP, REG. ESO-616384
T <sub>87</sub>	TERMINAL STRIP, REG. ESO-616384
T <sub>88</sub>	TERMINAL STRIP, REG. ESO-616384
T <sub>89</sub>	TERMINAL STRIP, REG. ESO-616384
T <sub>90</sub>	TERMINAL STRIP, REG. ESO-616384
T <sub>91</sub>	TERMINAL STRIP, REG. ESO-616384
T <sub>92</sub>	TERMINAL STRIP, REG. ESO-616384
T <sub>93</sub>	TERMINAL STRIP, REG. ESO-616384
T <sub>94</sub>	TERMINAL STRIP, REG. ESO-616384
T <sub>95</sub>	TERMINAL STRIP, REG. ESO-616384
T <sub>96</sub>	TERMINAL STRIP, REG. ESO-616384
T <sub>97</sub>	TERMINAL STRIP, REG. ESO-616384
T <sub>98</sub>	TERMINAL STRIP, REG. ESO-616384
T <sub>99</sub>	TERMINAL STRIP, REG. ESO-616384
T <sub>100</sub>	TERMINAL STRIP, REG. ESO-616384

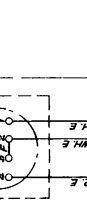
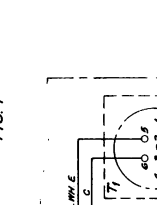
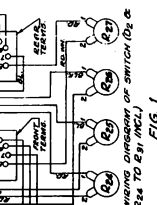
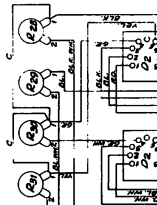

ASR-4412-4, ASSOCIATED WITH AMPLIFIERS, 66 TYPE  
ISSUE 4

WESTERN ELECTRIC SOUND SYSTEM  
ELECTRICAL RESEARCH PRODUCTS, INC. NEW YORK  
DRAWN BY: J.A.C. DATE: 3-22-58  
CHECKED BY: J.A.C. DATE: 3-25-58

SCALE: ASR-4412

ASR-4412



ASR-4413-5  
AMPLIFIER, 1086 TYPE

RECOMMENDED FOR USE IN THE HEAD OF 'TOP 1' MICROPHONE STAND OR WITH A 2 1/2" X 4 1/2" X 1 1/2" (TYPE) MICROPHONE STAND 135A-5 714-37 H 2

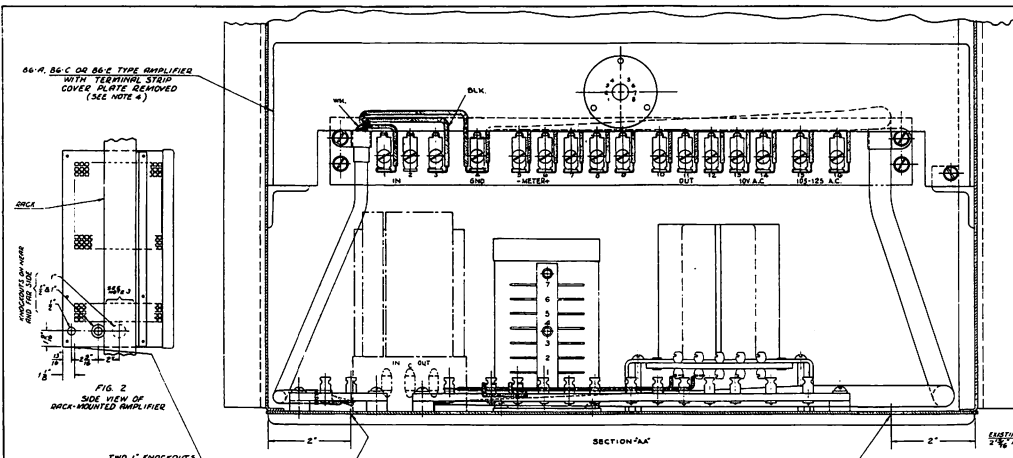

NOTE

1. THE 1086 TYPE AMPLIFIER CONSISTS OF THE FOLLOWING:

QUANTITY	DESCRIPTION
1	ASSEMBLY OF 6B-A, 6B-C OR 6B-E AMPLIFIER WITH TERMINAL STRIP COVER PLATE REMOVED (SEE NOTE 4)
1	70A-3711 TYPE APPARATUS UNIT
1	D-2386A FILTER
1	TR-4176 METER
1	70A-3711 TYPE APPARATUS UNIT AND LOCKWASHER 2 OF EACH REQUIRED
1	70A-3711 TYPE APPARATUS UNIT AND LOCKWASHER 2 OF EACH REQUIRED
1	70A-3711 TYPE APPARATUS UNIT AND LOCKWASHER 2 OF EACH REQUIRED
1	D-2386A FILTER (EQUIVALENT TO TR-7338 FILTER WILL BE AVAILABLE JAN. 1938.)

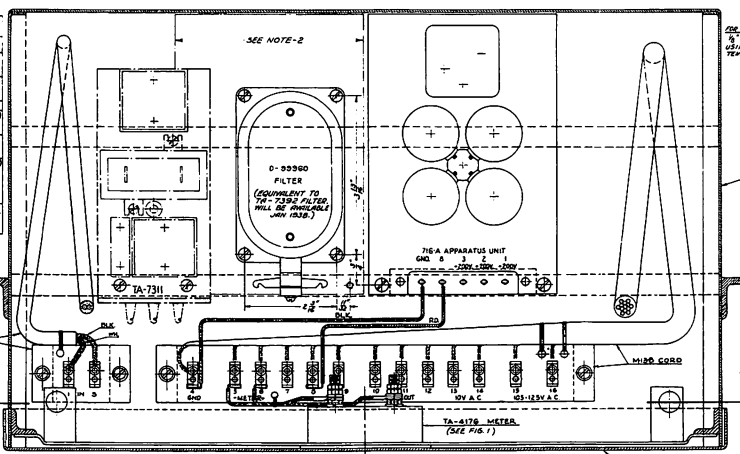

2. IF TWO 70A OR 70B APPARATUS UNITS ARE MOUNTED IN THE 70A CABINET, THE 70A-3711 TYPE APPARATUS UNIT IF REQUIRED, AND THE D-2386A FILTER, DUE TO SPACE LIMITATIONS, SHOULD BE MOUNTED ON THE 70A-3711 AND INSTALLED ON THE TOP SURFACE. THE D-2386A FILTER MAY ALSO BE MOUNTED ON THE 70A-3711 AND INSTALLED ON THE BOTTOM SURFACE (7 1/2" X 4 1/2").
3. INSTALL WIRING IN AMPLIFIER CABINET ON BRACKET PANELS WITH MOUNTING STRIPS OR RINGS. PROVIDE A CURVED SECTION OF 1/8" CABLE INSULATOR AND THE WIRING SHALL BE INSULATED TO PREVENT DAMAGE TO THE WIRES.
4. FOR ACCESS TO UNDERSIDE OF AMPLIFIER 3-08 CONTACTS FORMING ON BRACKET, INSULATE CONTACTS TO PREVENT SHORTS, AND REMOVE BOTTOM COVER.
5. DIMENSIONS 1 1/4" X 1 1/4" X 1 1/4" HEIGHT, 2 1/8" MOUNTS ON PANEL OR BRACKET, ALUMINUM ONLY.

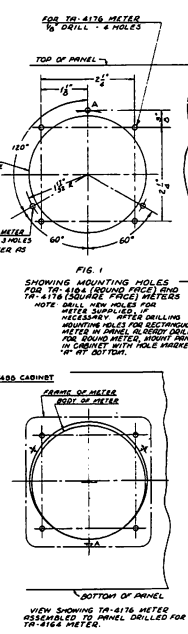

ASR-4413

ASO-4343 WIRING DIAGRAM  
ASSOCIATED DRAWINGS  
1086 TYPE AMPLIFIER

ASSEMBLY
WESTERN ELECTRIC SOUND SYSTEMS
ELECTRICAL RESEARCH PRODUCTS INC. NEW YORK
DESIGNED BY: J. E. SULLIVAN, JR.
CHECKED BY: J. E. SULLIVAN, JR.
DATE: 12-24-33
SCALE: FULL SIZE
ASR-4413

403 ASO-6343-4  
AMPLIFIER, 1086 TYPE

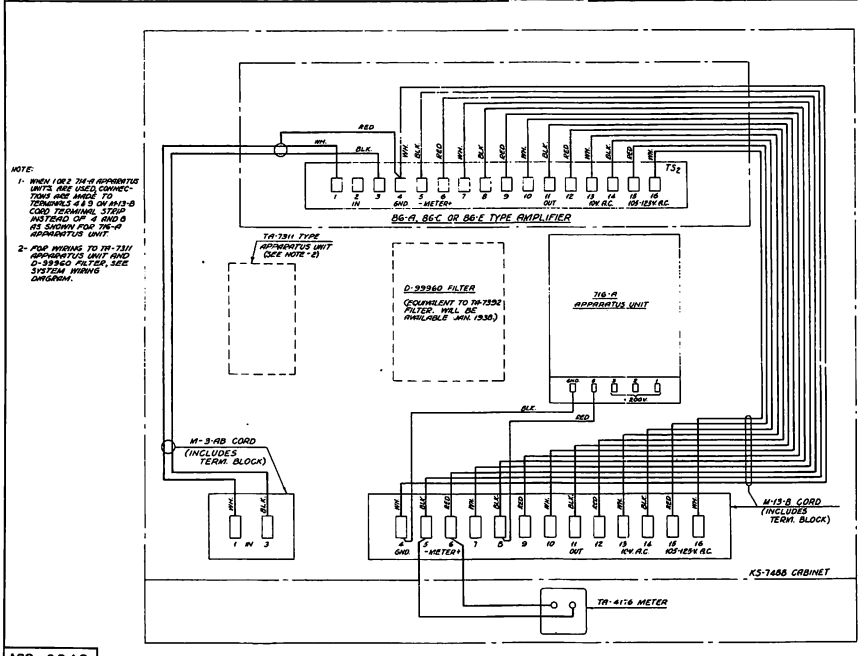

- NOTE:
1. WHEN TWO 70A APPARATUS UNITS ARE USED, CONNECTIONS 4 & 3 ON 70A-3711 CORD TERMINAL STRIP SHOULD BE INTERCHANGED INSTEAD OF 4 AND 5 AND 5 AND 3, FOR THE 70B APPARATUS UNIT.
2. FOR WIRING TO THE 70A APPARATUS UNIT AND D-2386A FILTER, SEE SYSTEM WIRING DIAGRAM.

RECOMMENDED FOR USE IN THE HEAD OF 'TOP 1' MICROPHONE STAND OR WITH A 2 1/2" X 4 1/2" X 1 1/2" (TYPE) MICROPHONE STAND 135A-5 714-37 H 2

ASO-6343 ASSEMBLY  
ASSOCIATED DRAWINGS  
1086 TYPE AMPLIFIER

WIRING DIAGRAM
WESTERN ELECTRIC SOUND SYSTEMS
ELECTRICAL RESEARCH PRODUCTS INC. NEW YORK
DESIGNED BY: J. E. SULLIVAN, JR.
CHECKED BY: J. E. SULLIVAN, JR.
DATE: 12-24-33
SCALE: FULL SIZE
ASO-6343

ASO-6343



**AMPLIFIERS, 86 TYPE** EQUIPMENT BULLETIN

3.012 This amplifier includes fixed potentiometers as follows:-

- (a) A single step of 5 db ahead of the first stage
- (b) 30 db in 10 db steps between the first and second stages
- (c) A single step of 10 db between the second and third stages

The potentiometer connections are changed by moving straps on terminal block TS-1 as indicated on the schematic. The first two stages may also be eliminated by proper strapping on the terminal block. The elimination of the first stage reduces the gain 21 db. Elimination of the first two stages reduces the gain 42 db. In the 86-A Amplifier (not A-86-A or C-86-A) the preferred method for reducing the gain is by eliminating stages 1 and/or 2, if the desired amount of reduction is at least 21 db.

3.013 Terminal block TS-2 provides terminals for the external connections to the amplifier and is situated behind removable cover plate of the chassis. A second block designated TS-1 is located behind TS-2. This block contains terminals which provide a means for adjusting potentiometer taps by strapping terminals as indicated on the schematic, and also provides access to various points in the circuit. Terminals on TS-2 are numbered 1 to 16 and on TS-1, 1 to 24. Since numbers from 1 to 16 appear on both terminal blocks, it should be remembered that TS-2 contains terminals for external connections and TS-1 for internal strapping, etc.

3.014 An 8 point switch and associated resistances are included in the amplifier in order that the currents in eight different circuits may be measured with a single external meter. The circuits thus equipped are the plate circuits of each of the amplifier tubes and the three external high voltage circuits.

3.015 The power transformer, T-4, is normally connected for supply voltages of 115 to 125 volts. For voltages between 105 and 115 volts, move wire from terminal 3 of transformer to terminal 2. Each amplifier should be fused separately with a #702 Buss Fuse (combined fuse and thermal cutout - 2 amp. rating).

3.02 The 1086-A Amplifier (Photo 9472) is an assembly of the following (described herein):-

- 1 - 86-A Amplifier
- 1 - KS-7488 Cabinet
- 1 - M-1-B Cord
- 1 - M-2-AB Cord
- 1 or 2 - 714-A Apparatus Units
- 1 - TA-4164 Meter

The assembled amplifier is 19-1/4" H x 19-1/2" W x 11-1/2" D overall, and weighs about 70 lbs. Its component equipment will ordinarily be listed separately in Equipment Lists, and the assembly number "1086-A" will be used on system drawings, etc.

3.03 The A-86-A Amplifier is the 86-A Amplifier modified (per TA-237) to include the TA-7704 Apparatus Unit. It is used in the Wide Range Systems having 52-A Amplifiers and the TA-7704 Apparatus Unit and D-96926 Retard Coil supplied for the required horn and film equalization for such systems. In the A-86-A Amplifier the first and/or second stage equalization may be eliminated. The interesting potentiometers may be set as required, except that the 70 db setting of the second potentiometer must not be used, since the permissible loss between stages 1 and 2 would be exceeded by the 30 db attenuation plus that of the TA-7704 Unit. The normal setting for the second potentiometer is on the -20 db step and this setting should be used wherever possible. The data in 3.01 on the 86-A Amplifier, applies to the A-86-A, except as follows:-  
Gain - - - - - In KS-7488 Cabinet, as component of A-1086-A Amplifier  
Mounting - - - - - At 1000 cps, 89 db maximum, 54 db minimum.

3.04 The A-1086-A Amplifier is an assembly of the following:-

- 1 - A-86-A Amplifier
- 1 or 2 - 714-A Apparatus Units
- 1 - KS-7488 Cabinet
- 1 - M-1-B Cord
- 1 - D-96926 Retard Coil
- 1 - M-2-AB Cord

The above equipment will ordinarily be listed separately in Equipment Lists, and the assembly number "A-1086-A" will be used on systems drawings, etc.

3.05 The B-86-A Amplifier is the same as the 86-A Amplifier except that it operates from a 105-125V, 47-63 cycle supply. The power transformer T4 is D-96970, instead of 332-B.

3.06 The B-1086-A Amplifier is the same as the 1086-A Amplifier, except that the component amplifier is B-86-A.

3.07 The C-86-A Amplifier is the same as the A-86-A, except that it operates from a 105-125V, 47-63 cycle supply. The power transformer T4 is D-96970, instead of 332-B. The information and restrictions in 3.03 above, for the A-86-A Amplifier, apply to the C-86-A as well.

5 Pages - Page 2 Electrical Research Products Inc  
Operating Engineering Dept. - Equipment Div. Issue #1  
December 21, 1934

**AMPLIFIERS, 86 TYPE** EQUIPMENT BULLETIN

**1. ASSOCIATED DRAWINGS & PHOTOGRAPHS**

- ASR-4412 - 86-A & A-86-A Amplifiers, Wiring
- ASO-6740 - 86-A & A-86-A Amplifiers, Schematic
- ASR-4413 - 1086-A & A-1086-A Amplifiers, Assembly
- ASO-6743 - 1086-A & A-1086-A Amplifiers, Wiring
- ASO-6745 - 714-A Apparatus Unit, Schematic & Wiring
- ASL-2767 - 716-A Apparatus Unit, Schematic & Wiring
- ASO-6325 - TA-7704 Apparatus Unit, Assembly & Wiring

Photos #9468 - 86-A Amplifier, Front View  
#9470 - 86-A Amplifier, Bottom View - Cover Removed  
#9472 - 1086-A Amplifier  
#9473 - 1086-A Amplifier, Door and Meter Panel Removed

**2. INDEX**

Code	Description	Sect. #
86-A	Amplifier	3.01
A-86-A	Modified for Wide Range equalization	3.03
B-86-A	Modified for 115V, 50 Cycle operation	3.05
C-86-A	Modified for 115V, 50 Cycle operation	3.07
1086-A	Amplifier	3.02
A-1086-A	Same as 1086-A, except has A-86-A Amplifier	3.04
B-1086-A	Same as 1086-A, except has B-86-A Amplifier	3.06
C-1086-A	Same as 1086-A, except has C-86-A Amplifier	3.08
KS-7488	Cabinet	3.09
M-1-B	Cord	3.10
M-2-AB	Cord	3.11
714-A	Apparatus Unit	3.12
716-A	Apparatus Unit	3.13
TA-4164	Meter	3.14
D-96926	Retard Coil	3.15
TA-7704	Apparatus Unit	3.03
ASL-2809	Trough	4.02

**3. DESCRIPTION**

3.01 86-A Amplifier (Photos 9468 & 9470)

3.011 Tabulation of Data:

General	- - - - - All 40 operated, four stages, dish type chassis
Dimensions (Overall)	- - - - - 16-3/4" wide x 8-1/2" high x 10" deep
Weight	- - - - - 35 lbs.
Mounting	- - - - - In KS-7488 Cabinet, as component of 1086-A Amplifier, or separately for special uses
Stages	- - - - - 4 (2 resistance, and 2 transformer coupled)
Gain	- - - - - 99 db maximum, 47 db minimum (see Section 3.012)
Output	- - - - - 15 watts (34 db) minimum, with 1/3 third harmonic
Frequency Characteristic	- - - - - Flat within 1 db - 40 to 10,000 cycles
Input Impedance	- - - - - Operates from 200 ohms; Impedance into amplifier 910 ohms
Output Impedance	- - - - - 6 ohm tap (1.6W) operates into 3.5 ohm to 7.5 ohm load
Noise Level	- - - - - 12 ohm tap (3.7W) operates into 7.5 ohm to 15 ohm load
Vacuum Tubes Required	- - - - - 1st Stage, 1 - 262-A
	- - - - - 2nd Stage, 1 - 262-A
	- - - - - 3rd Stage, 1 - 262-A
	- - - - - 4th Stage, 2 - 300-A (PP)
	- - - - - Rectifier, 1 - 274-A
Ambient Temperature	- - - - - 1150 F. max.
Power Supply	- - - - - 105-125V, 60 Cycles ± 5%; 160 watts maximum
Special Features	- - - - - (a) One 10 volt, 1 ampere, AC output for supplying filament current for 62-A Amplifiers;
	- - - - - (b) Three high voltage circuits intended for supplying plate current to preliminary amplifiers through suitable filters.

5 Pages - Page 1 Electrical Research Products Inc  
Operating Engineering Dept. - Equipment Div. Issue #1  
December 21, 1934



## AMPLIFIERS, 86 TYPE

## EQUIPMENT BULLETIN

3.08 The C-1086-A Amplifier is the same as the A-1086-A Amplifier, except that the component amplifier is C-86-A.

3.09 The KS-7488 Cabinet (Photo 9471) is a perforated metal box with a removable front cover. It serves as a housing for the amplifier and associated equipment and is designed to mount on the wall or on a relay rack. The box is approximately 19-1/4" high, 10-5/8" deep and 3-1/8" wide including mounting flanges. The amplifier mounts in the upper part of the cabinet supported by angle iron brackets on each side. The lower compartment provides mounting space for one or two 714-A (or one 714-A and one 716-A) Apparatus Units, terminal blocks, meter and retard coil. The front cover contains a small hole for access to the meter switch on the amplifier, and a larger hole near the bottom behind which the meter is mounted. Knockouts for 1" and 1/2" conduits are located on each side of the cabinet, and a knockout for 1" conduit is located on each side of the bottom of the cabinet near the rear. The finish is rough dark gray aluminum and the perforations in the cover are arranged in panels.

3.10 The M-13-B Cord is a 13 conductor cord made up in the form of a "U" shaped cable, one end of which is connected to a terminal block 10-1/2" long and 1-3/8" wide, and the other end is fanned into skimmers 2-1/2" long with 1" bare ends. This cord is used to bring out the terminals (except input) of the 86 type Amplifier so that connections may be made to the 714-A (or 716-A) Apparatus Unit(s) and the external circuitry. Flexible wires are provided on the terminal block for connecting to the RA-7304 Meter. The terminal block is mounted in the KS-7488 Cabinet as shown in Photo 9473. Means of two screws which are supplied with the cord. The cable is run up the right side of the cabinet and into the amplifier where the skimmers are connected to the terminals on TS-2. The first skimmer at the extreme end of the cable connects to terminal #4 and from this point the skimmers fan out toward the right until the last one is connected to terminal #16. The wires in the cable are not color coded but the skimmers are fanned out so that they come in the proper order to connect to the required terminals. The connections should be such that terminals designated by the same numbers on the two terminal blocks are connected together. The cord is long enough to permit turning the amplifier up on its side in the cabinet without disconnecting the wires.

3.11 The K-3-AB Cord is a two conductor shielded cord, one end of which terminates in a terminal block 2-3/8" long and 1-3/8" wide equipped with two terminals to which the conductors are connected. At the other end the conductors terminate in 1" bare ends and a 7" length of red rubber-covered flexible wire is soldered to the shield. This cord is used to bring out the input terminals of the amplifier. The terminal block is mounted near the lower left corner of the cabinet (see Photo 947) by means of two screws supplied with the cord. The cord is run through a space in the base of the amplifier and the white conductor connected to terminal #1 on 19-2 and the black conductor to terminal #3. The red conductor is connected to ground at terminal #4. The cord is long enough to permit turning the amplifier up on its side without removing the connections.

3.12 The 714-A Apparatus Unit provides filtering for the plate current supply to two PEC Amplifiers (49 or 62 type), from the 86-A type Amplifier. It consists of condensers, resistors, and retard coils mounted on a steel base, and the overall dimensions are 7" long x 4-1/2" wide x 4-3/4" high. One or two 714-A Units will mount in the lower compartment of the KS-7488 Cabinet, as shown on ASR-4413. Normally, one unit will be used, but in a machine installation the second unit may be added and one machine supplied from it. In such cases, the capacity of the rectifier in the 86-A type Amplifier does not permit the supplying of more than three PEC Amplifiers in this manner. If the PEC Amplifiers are 62-A type (normally requiring a 120V and 90V supply), the 120V and 90V terminals on the 714-A Unit should be strapped, in which case the single voltage from the 714-A Unit to each 62-A type Amplifier will be about 95V, which provides satisfactory operation. Two wires are attached to the terminal strip of the apparatus unit for connecting to the terminal strip of the M-13-B Cord.

3.13 One 716-A Apparatus Unit may be installed in the KS-7488 Cabinet in addition to one 714-A Unit to provide filtering for the plate current supply to one 80 type Amplifier. The 716-A Unit consists of condensers and a retard coil mounted on a steel base and the overall dimensions are 7" long x 4-1/2" wide x 4-3/4" high. The input should be connected to terminals 8 and 9 and on the amplifier. There are three 200V outputs, only one of which may be used where a 714-A Apparatus Unit is also being supplied from the 86 type Amplifier. If two 714-A Units are installed, in a 1086 type Amplifier, the 716-A Unit cannot be installed.

5 Pages - Page 3 Electrical Research Products Inc  
Operating Engineering Dept. - Equipment Div.

Issue #1  
December  
21, 1954

## EQUIPMENT BULLETIN

## AMPLIFIERS, 86 TYPE

3.14 The RA-7484 Meter is a Weston Model 301 Milliammeter having a flush bakelite case, a range of 0-12 milliamperes and a resistance of 25 ohms  $\pm$  2%. The scale is designated O-150 and marked "Percent" instead of "milliamperes". The meter is calibrated to read 100 on the scale for 1 milliampere current. The meter is mounted on the panel provided in the lower compartment of the KS-7488 Cabinet and connected to the two flexible leads from terminals 5 and 6 on the terminal block of the M-13-B Cord. The meter switch control is located on the amplifier and appears as a slotted shaft through a hole in the cover of the KS-7488 Cabinet directly above the meter. One end of the slot is marked with two black dots; this end indicates the positions of the switch which are numbered 1 to 8, corresponding to circuits as follows:-

- #1 - Plate circuit of the first 262-A Vacuum Tube
- #2 - Plate circuit of the second 262-A Vacuum Tube
- #3 - Plate circuit of the third 262-A Vacuum Tube
- #4 - Plate circuit of the first 300-A Vacuum Tube
- #5 - Plate circuit of the second 300-A Vacuum Tube
- #6 - 400V External high voltage supply circuit
- #7 - 260V External high voltage supply circuit (one 716-A Apparatus Unit)
- #8 - 130V External high voltage supply circuit (one or two 714-A Apparatus Units)

In order to measure the current in one of these circuits the marked end of the slot should be turned to a point opposite the proper number. The resistance across which the meter is connected in each of the positions is of such value that if the current in the circuit is normal, the meter will read 100%.

Referring to ASO-6340, it will be noted that there are three external high voltage supplies from the rectifier of the 86-A type Amplifier, namely from terminals 7, 8 and 9, corresponding to meter switch Positions 6, 7 and 8 respectively. The supply from terminal 9 (switch Position 8) will be used for one or two 714-A Apparatus Units, and the resistance in this circuit will differ for 49 and 62 type PEC Amplifiers, and the resistance for such as to give a 100% reading for two 49 type Amplifiers. For two 62-A type Amplifiers, the normal meter reading will be about 86%. Tentative limits for readings on this meter are  $\pm$  15%.

3.15 The D-96926 Retard Coil is connected in one side of the input to the amplifier, and functions to attenuate frequencies above 5000 cycles. It is, in effect, a part of the equalization required for Wide Range Systems supplementing that provided by the RA-7304 Apparatus Unit in the Amplifier.

## 4. INSTALLATION

4.1 Mount the RA-7488 Cabinet in position on the rack or wall; for wall mounting the angle iron brackets may be moved to the back edges of the sides, using the holes provided. Remove meter panel and install one or two 714-A Apparatus Units and one D-96926 Retard Coil (only if amplifier is A-86-A or C-86-A) on the terminal blocks of the M-3-AB and M-13-B Cords in position, as shown on ASR-4413. Mount the amplifier on its shelf, remove front cover plate, mount the RA-7484 Meter on its panel, and make the cord connections to the 86-A type Amplifier, 714-A Apparatus Unit(s), D-96926 Retard Coil (if used) and RA-7484 Meter, as per ASO-6433. Make external connections (see 4.2 below) as shown on Systems Settings, 011. Replace the plate and meter panel, and install vacuum tubes as per Settings, 011. Replace the front cover of the amplifier. Finally, fasten the amplifier to the cabinet by means of a screw through the hole in the lower right corner of the front of the chassis, into the tapped hole in the bracket on the cabinet (Photo 9473). The cabinet includes a 164-32x3/8" R.H.I.K. Screw for this purpose.

4.2 With systems where the 1066-A type Amplifier is wall mounted, an ASL-2509 Trough is supplied as a separate item. This is a steel box 17-1/8" x 3-1/8" x 2-1/2" high, with a removable cover and with 2 - 1" knockouts each on the top, bottom, and back, 1 - 1" knockout in one end, and 1 - 1-1/4" knockout in the other end. Its purpose is to facilitate conduit and wiring connections. The conduit knockouts on the top of the trough line up with those on the bottom of the KS-7488 Cabinet, and the trough should be attached to the bottom of the cabinet by means of two Chase Phillips and locknuts; since the two ends have different size knockouts, the trough should be assembled to the amplifier with this in view, relative to the conduit arrangement. Conduit may be brought in to the back, bottom or ends of the trough.

## 5. ADJUSTMENT AND OPERATION

5.1 The method of adjusting the gain of the 86-A type Amplifier is described in Section 3.012 and on Schematic ASO-6340. The limitations on this adjustment in the cases of the A-86-A and C-86-A Amplifiers are covered in Section 3.03. As received, the amplifier is set for maximum gain. The use of the RA-7484 Meter and

5 Pages - Page 4 Electrical Research Products Inc  
Operating Engineering Dept. - Equipment Div.

Issue #1  
December  
21, 1954



## EQUIPMENT BULLETIN

## AMPLIFIERS, 86 TYPE



associated switch is described in Section 3.13. The meter switch may be operated by either a screw driver or a coin. Its use is not intended to be part of the regular system operating procedure, but rather for trouble hunting, tube testing and occasional general check on the amplifier circuits. The routine operation of the sound system requires no manipulation of the 1086-A type Amplifier.

6. USE OF 1086-A TYPE AMPLIFIER IN SOUND SYSTEMS HAVING PUBLIC ADDRESS ATTACHMENTS, OR NS-A ATTACHMENTS

6.1 When the 86-A type Amplifier is used to amplify sources of pick-up in addition to those of the sound system (such as P.A., Announcing, or Non-Synchronous), suitable attenuation in the higher level pick-ups must be provided, since the amplifier has no operating gain control. For P.A. Attachments, using an 80 type Amplifier the 716-A Apparatus Unit should be used to supply the 200V plate voltage. The 716-A Unit mounts in the KS-7485 Cabinet similarly to, and in addition to one 714-A Apparatus Unit. The total number of preliminary amplifiers which may be supplied with plate current from an 86 type Amplifier is three. Accordingly, if a 716-A Apparatus Unit is operated in addition to a 714-A Apparatus Unit supplying two 4g or 62 type Amplifiers, the 716-A Unit may supply but one 80 type Amplifier.

6.2 In a Wide Range System using 62 type P80 Amplifiers, the normal arrangement is to use the A-86-A or O-86-A Amplifier which includes the horn and film equalization. Information on the use of these amplifiers (having modified characteristics) jointly with Public Address or other Attachments will be given later.

7. MERCHANDISING

7.1 The components of the 1086-A and A-1086-A Amplifiers (Section 3), are available in the Stores Division. Order them as:-

- 1 - 86-A (or A-86-A) Amplifier
- 1 - KS-7485 Cabinet
- 1 - M-13-B Cord
- 1 - M-7-AB Cord
- 1 - 714-A Apparatus Unit
- 1 - TA-4164 Meter

7.2 The B-86-A and C-86-A Amplifiers will be available about January 1, 1935.

7.3 All electrical parts of these amplifiers are separately replaceable, and may be ordered from the Stores Division, using the names and code numbers specified on the drawings.

7.4 The 716-A Apparatus Unit will not be stocked, but is available on an "As Ordered" basis.



1. ABSTRACT

1.1 This addendum is issued (a) to correct the values for ambient temperature and required power supply watts, as specified in the Equipment Bulletin. (b) To provide information on the TA-7311 Apparatus Unit.

2. ASSOCIATED DRAWING

ASL-2818 - TA-7311 Apparatus Unit, Wiring Diagram & Schematic.

3. CORRECTIONS

3.1 In Section 3.011 of the Equipment Bulletin, make the following changes on all copies:-  
Ambient Temperature - - - - 110° F. Max.  
Power Supply - - - - - 105-125V, 60 Cycles ± 5%, 130 Watts Max.

4. TA-7311 APPARATUS UNIT

4.1 This apparatus unit consists of the apparatus and circuit shown on ASL-2818 arranged as a compact unit 4-3/4" x 2-3/4" x 4-3/4" H. When connected in the input to the 1086-A Amplifier (ahead of input terminals) the combination provides the same loudspeaker and film equalization as the A-1086-A, and is accordingly the electrical equivalent of the latter. It has the advantage that no internal modification of the 86-A Amplifier is involved, and its characteristic for Public Address or other additional use is unchanged. In cases of such P.A. or other use of the 86 type Amplifier, the TA-7311 Apparatus Unit should of course be connected in the input to the 86-A Amplifier. The TA-7311 Apparatus Unit should be connected in the output to bring the sound level to the same level, it should be inserted between the fader and the TA-7311 Unit. This is shown in Figures 1 and 2 below.

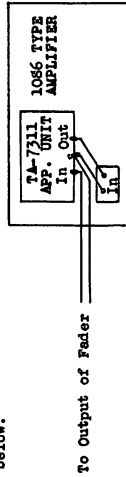

FIGURE 1  
SHOWING TA-7311 APPARATUS UNIT, INSTALLED IN KS-7485 CABINET

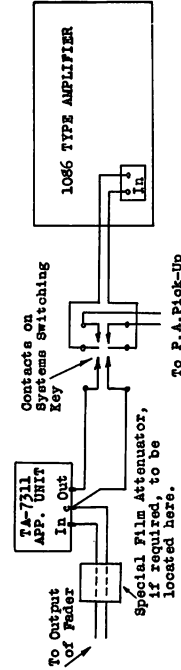

FIGURE 2  
SHOWING TA-7311 APPARATUS UNIT MOUNTED ON RACK AND CONNECTED TO P.A. PICK-UP, AT INSTALLATION HAVING AN ASSOCIATED P.A. SYSTEM

4.2 The TA-7311 Apparatus Unit may be mounted either in the KS-7485 Cabinet, or on a rack or in a rack. The mounting holes, the spacing between the front and back holes are spaced to fit a terminal block. The bottom of the unit is behind and to the right of the input terminal block. For panel mounting, one front and one rear hole should be used. Two #4 (.164")-32x1-9/16 R.H. ST. M. Screws with lockwashers are supplied with the unit. The apparatus unit should ordinarily be mounted in the KS-7485 Cabinet. However, if there is an associated P.A. or other special system also using the 1086-A type Amplifier, the mounting of the apparatus unit on the D-88704 or equivalent switching panel is desirable. 4.3 When located elsewhere than in the KS-7485 Cabinet, it should be placed as far as possible from power transformers, retard coils, or other sources of noise. If a high noise level results from its installation in a particular place, it should be shifted until a satisfactory location is found.

5. MERCHANDISING

5.1 TA-7311 Apparatus Units are available in the Stores Division. They will not be shipped generally until the stock of A-86-A Amplifiers is exhausted or unless specifically required as outlined above. Order as: "One - TA-7311 Apparatus Unit".



4.03

AMPLIFIERS, 86 TYPE  
ADDENDUM #2

EQUIPMENT BULLETIN

1. ABSTRACT

- 1.1 This addendum supplies information on:
- The use of the TA-4164 Meter in indicating the normal plate supply to PEC Amplifiers (Section 2).
  - Supplementary data on the operating characteristics of the output stage (Section 3).
  - The 86-C Amplifier (Section 4).
  - The discontinuance of records; the 1086-A type Amplifier to conform with variations in its components (Section 5).
  - The permalloy lining in the shield over V1 in 86 type Amplifiers (Section 6).
  - The use of the D-96970 Transformer and 159-B Output Transformer as the standard replacements for T4 and T3, respectively in all 86-A and 86-C type Amplifiers (Section 7).

2. USE OF TA-4164 METER TO INDICATE CURRENT SUPPLY TO PEC AMPLIFIER PLATE CIRCUITS

2.1 With the KS-7493 Switch in position #3, the TA-4164 Meter indicates a percentage based upon a current of .0096 ampere, supplied from terminal #9 of the 86 type Amplifier, as 100%. This is the average current taken by a load of one 714-A Apparatus Unit and two 49 type Amplifiers. If the load on this circuit is other than this, the normal reading will be other than 100%; for one 714-A Apparatus Unit and two 62-A Amplifiers, it is approximately 80%. To convert any reading into "percentage of normal", divide the actual reading by the normal reading. For instance, if the load is one 714-A Apparatus Unit and two 62-A Amplifiers, and the reading is 70%:

$$\frac{.70}{.80} = 87.5\% \text{ of normal.}$$

2.2 The meter reading for position #3 on the switch, should be taken with all PEC Amplifiers "on".

3. OPERATION OF 300-A VACUUM TUBES IN 86 TYPE AMPLIFIER

3.1 In installing 300-A Vacuum Tubes in the 86 type Amplifier, no attempt need be made to make the plate currents balance. The meter reading for either of the output tubes may be between 75% and 125%, with a maximum difference of 50% of nominal, without appreciable harmonic distortion. Such relatively large differences in plate resistance are characteristic of low impedance tubes, the average resistance for 300-A Tubes being 700 ohms.

3.2 A varying plate current in the tubes of the last stage is not necessarily an indication of overloading. The variation changes with change of tubes, and may amount to as much as 10% without overload. This is partly characteristic of the low resistance tubes, and partly because of certain features inherent in the circuit design of the amplifier.

4. 86-C AMPLIFIER

4.1 The 86-C Amplifier will supersede the 86-A type, as soon as existing stocks of the latter are exhausted (about July 8, 1955). The 86-C Amplifier is the same as the 86-A, except as follows:

- The output transformer T3 is 159-B instead of 166-A.
- The power transformer T4 is D-96970 instead of 312-B.
- On resistance R5, the tap is taken at a different position.

4.2 As a result of the above features the performance of the 86-C Amplifier differs from that of the 86-A, as follows:

- The output at low frequencies, for a given amount of harmonic distortion is greatly increased.
- The amplifier may be operated from a power supply of 105-125 volts, 50-65 cycles AC.

2 Pages - Page 1

Electrical Research Products Inc.

Operating Engineering Dept. - Equipment Div.

Issue #7  
July 9, 1955

4.03

AMPLIFIERS, 86 TYPE  
ADDENDUM #2

EQUIPMENT BULLETIN

5. 1086-A TYPE AMPLIFIER

5.1 The assembly code number 1086-A, appearing on the KS-7483 Cabinet, will designate the combination of an 86-A, or 86-C type Amplifier, with its various accessories. The "1086-A" will, in the future, be kept intact even though the component amplifier is modified to A-86-A, B-86-A, etc., or if the component be an 86-C. The codings A-1086-A, B-1086-A and C-1086-A, heretofore used are now discontinued, and the main E.R. should be so marked. The associated drawings are being reissued accordingly.

6. VACUUM TUBE SHIELD FOR V51

6.1 The shield provided for vacuum tube socket V51, has a permalloy lining, and it is essential that it be used in this position. The shield is marked V51 on top, to distinguish it from the other shields, which are unmarked.

7. USE OF D-96970 TRANSFORMER AND 159-B OUTPUT TRANSFORMER FOR REPLACEMENTS

7.1 After the exhaustion of the existing stock of 732-B Transformers, the D-96970 Transformer will be the standard replacement for T4 in all 86-A and 86-C type Amplifiers (see 4.2 above). When a 732-B Transformer is replaced by a D-96970 Transformer in an 86-A type Amplifier, the latter should be recoded to B-86-A or (if previously A-86-A) to C-86-A (see Sections 4.1 and 4.2 (b)).

7.2 After the exhaustion of the existing stock of 166-A Output Transformers, the 159-B Output Transformer will be the standard replacement output transformer for T3 in all 86-A and 86-C type Amplifiers (see 4.2 above). This substitution does not affect the coding.

7.3 Refer to associated drawings ABR-4412 or A80-6340 for editing information, in ordering replacements for transformers T3 and T4. These drawings will be reissued accordingly, at the time the above changes become effective.

2 Pages - Page 2

Electrical Research Products Inc.  
Operating Engineering Dept. - Equipment Div.Issue #7  
July 9, 1955





1. ABSTRACT (\* denotes new item or items changed in this issue)

- 1.1 This addendum supplies information on:
  - (a) The use of the TA-4164 Meter in indicating the normal plate supply to PFC Amplifiers (Section 2).
  - (b) Supplementary data on the operating characteristics of the output stage (Section 3).
  - (c) The 86-C Amplifier (Section 4).
  - (d) The discontinuance of recoding the 1086-A type Amplifier to conform with variations in its components (Section 5).
  - (e) The permalloy lining in the shield over 7V1 in 86 type Amplifiers (Section 6).
  - (f) The use of the D-9670 Transformer and 159-B Output Transformer as the standard replacements for 74 and 73, respectively in all 86-A and 86-C type Amplifiers (Section 7).
  - (g) The D-97846 Shield (permalloy) for the power transformer of the 86 type Amplifier (Section 8).
  - (h) Handling and care of permalloy shields and cores. (Section 9).

2. USE OF TA-4164 METER TO INDICATE CURRENT SUPPLY TO PFC AMPLIFIER PLATE CIRCUITS

2.1 With the KS-7493 Switch in position #8, the TA-4164 Meter indicates a percentage based upon a current of .0096 ampere, supplied from terminal #9 of the 86 type Amplifier, as 100%. This is the average current taken by a load of one 714-A Apparatus Unit and two 49 type Amplifiers. If the load on this circuit is other than this, the normal reading will be other than 100%; for one 714-A Apparatus Unit and two 62-A Amplifiers, it is approximately 80%. To convert any reading into percentage of normal, divide the actual reading by the normal reading. For instance, if the load is one 714-A Apparatus Unit and two 62-A Amplifiers, and the reading is 70%:

$$\frac{.70}{.80} = 87.5\% \text{ of normal.}$$

2.2 The meter reading for position #8 on the switch, should be taken with all PFC Amplifiers "on".

3. OPERATION OF 300-A VACUUM TUBES IN 86 TYPE AMPLIFIER

- 3.1 In installing 300-A Vacuum Tubes in the 86 type Amplifier, no attempt need be made to make the plate currents balance. The meter reading for either of the output tubes may be between 75% and 125%, with a maximum difference of 50% of nominal, without appreciable harmonic distortion. Such relatively large differences in plate resistance are characteristic of low impedance tubes, the average resistance for 300-A tubes being 700 ohms.
- 3.2 A varying plate current in the tubes of the last stage is not necessarily an indication of overloading. The variation changes with change of tubes, and may amount to as much as 10% without overload. This is partly characteristic of the low resistance tubes, and partly because of certain features inherent in the circuit design of the amplifier.

4. 86-C AMPLIFIER

- 4.1 The 86-C Amplifier will supersede the 86-A type, as soon as existing stocks of the latter are exhausted (about July 8, 1955). The 86-C Amplifier is the same as the 86-A, except as follows:
  - (a) The output transformer T<sub>3</sub> is 159-B instead of 166-A;
  - (b) The power transformer T<sub>4</sub> is D-9670 instead of 552-B.
  - (c) On resistance R<sub>5</sub>, the tap is taken at a different position.
- 4.2 As a result of the above features the performance of the 86-C Amplifier differs from that of the 86-A, as follows:
  - (a) The output at low frequencies, for a given amount of harmonic distortion, is greatly increased.
  - (b) The amplifier may be operated from a power supply of 105-125 volts, 50-65 cycles AC.

5. 1086-A TYPE AMPLIFIER

5.1 The assembly code number 1086-A, appearing on the KS-7493 Cabinet, will designate the combination of an 86-A or 86-C type Amplifier with its various accessories. The "1086-A" will in the future be kept intact even though the component amplifier is modified to A-86-A, B-86-A, or C-86-A. If the component is 86-C the coding A-1086-A, B-1086-A and C-1086-A, heretofore used, are now discontinued, and the main E.B. should be so marked. The associated drawings are being reissued accordingly.

6. VACUUM TUBE SHIELD FOR 7S1

6.1 The shield provided for vacuum tube socket 7S1, has a permalloy lining, and it is essential that it be used in this position. The shield is marked 7S1 on top, to distinguish it from the other shields, which are unmarked.

7. 159-B OUTPUT TRANSFORMER FOR REPLACEMENTS

7.1 After the exhaustion of the existing stock of 332-B Transformers, the D-9670 Transformer will be the standard replacement for T<sub>3</sub> in all 86-A and 86-C type Amplifiers (see 4.2 above). When a 332-B Transformer is replaced by a D-9670 Transformer in an 86-A type Amplifier, the latter should be recoded to B-86-A or (if previously A-86-A) to C-86-A (see Sections 4.1 and 4.2 (b)).

7.2 After the exhaustion of the existing stock of 166-A Output Transformers, the 159-B Output Transformer will be the standard replacement output transformer for T<sub>3</sub> in all 86-A and 86-C type Amplifiers (see 4.2 above). This substitution does not affect the coding.

7.3 Refer to associated drawings ASR-4412 or ASO-6340 for editing information. In ordering replacements for transformers T<sub>3</sub> and T<sub>4</sub>, these drawings will be reissued accordingly, at the time the above changes become effective.

\*8. D-97846 SHIELD FOR POWER TRANSFORMERS

8.1 The D-97846 shield is an inverted rectangular box of double sheet permalloy which slips over the D-9670 (or 332-B) Transformer (power) of the 86-C (or 86-A) Amplifier. It is 4-1/16" x 5-1/4" x 5/8" H, inside dimensions.

8.2 This shield is furnished only for vertical disc or other very low input-level systems using the 86 type Amplifier. It may be ordered only on approval of Division Operating Managers.

\*9. PERMALLOY SHIELDS AND CORES - HANDLING

9.1 Great care should be taken in handling or shipping permalloy shields, also transformers or coils having permalloy cores, to avoid jarring, pounding or bending. Misreatment of this kind results in reducing the property of high permeability.



## EQUIPMENT BULLETIN

1. ABSTRACT

1.1 This addendum describes a method of facilitating the connecting of ground wires on 1086 type Amplifiers; also of enclosing a 1086 type Amplifier when mounted in and extending through the booth wall.

2. GROUND CONNECTIONS ON 1086 TYPE AMPLIFIERS

2.1 Where the 1086 type Amplifier is used as a ground center for the complete system, an additional ground terminal should be installed for the ground wires to connect to. This terminal should be improvised by the engineer and installed under the head of the mounting screw adjacent to the regular ground terminal on the terminal strip of the M-13-B Cord. The hole into which the screw threads should first be carefully cleaned to insure a good connection with the cabinet.

3. MOUNTING 1086 TYPE AMPLIFIER IN WALL

3.1 If the 1086 type Amplifier is mounted so that it extends through the booth wall, the exhibitor should build a fire-proof enclosure, allowing at least 6" clearance, around all sides of the amplifier. This will preserve the fire-proof continuity of the original wall and assure sufficient ventilation around the amplifier.



## EQUIPMENT BULLETIN

1. ABSTRACT (\* Indicates new or changed items)

## 1.1 This addendum specifies:

(a) A method for connecting ground wires on 1086 type Amplifiers (Sect. 2).  
(b) The use of a fireproof enclosure around the 1086 type Amplifiers, where the latter is mounted in the booth wall (Sect. 3).

(c) The addition of a label on the front cover plate, indicating the gain setting for the convenience of the Service Inspector (Sect. 4).

2. GROUND CONNECTIONS ON 1086 TYPE AMPLIFIERS

2.1 Where the 1086 type Amplifier is used as a ground center for the complete system, an additional ground terminal should be installed for the ground wires to connect to. This terminal should be installed under the head of the mounting screw adjacent to the regular ground terminal on the terminal strip of the M-13-B Cord. The hole into which the screw threads should first be carefully cleaned to insure a good connection with the cabinet.

3. MOUNTING 1086 TYPE AMPLIFIER IN WALL

3.1 If the 1086 type Amplifier is mounted so that it extends through the booth wall, the exhibitor should build a fire-proof enclosure, allowing at least 6" clearance, around all sides of the amplifier. This will preserve the fireproof continuity of the original wall and assure sufficient ventilation around the amplifier.

\*4. LABEL TO INDICATE AMPLIFIER GAIN SETTING

4.1 General: Heretofore it has been necessary for the Service Inspector to raise the 86 type Amplifier, remove its bottom cover, and examine the strappings on T3, to ascertain the gain setting of the amplifier, or the primary connections to transformer T4. In order to obviate this inconvenience a label containing this information is to be placed on the front cover plate, of each 86 type Amplifier already installed, or installed in the future. Several of these labels are attached hereto, and should be cut from this sheet and used as described below.

4.2 Procedure: After the gain of an 86 type Amplifier has been finally adjusted, the inspector should sign and date one of the attached labels on the line showing the gain and strapping conditions as set, and also indicate on that line, the approximate line voltage and terminal connections to the primary of transformer T4. The label shows a variety of gains from 99 DB to 47 DB, with the particular strapping for each. Fasten the label to the right side of the removable front cover plate of the 86 type Amplifier so that it is readily seen upon removing the door of the KS-7455 Cabinet. Should it subsequently become necessary to change the gain of the amplifier, the label should be revised or replaced.

4.3 Exception: The settings as shown on the labels are not correct for the A-26-A and C-26-A Amplifiers, the gain of which is maximum 87 DB, minimum 52 DB, and elimination of stages is NOT permissible (see E.S.) for these amplifiers, the setting should be written in on the label, in the blank space provided.



EQUIPMENT BULLETIN

4.03  
AMPLIFIERS, 86 TYPE - INTERNALIZATION, OPERATION, MAINTENANCE



EQUIPMENT BULLETIN

4.03  
AMPLIFIERS, 86 TYPE - INTERNALIZATION, OPERATION, MAINTENANCE

1. 86 TYPE AMPLIFIER - The #86 Amplifier is an all "AC" operated, four stage (5 tubes), combined voltage gain and power, chassis type amplifier unit, with an internal rectifier (1 tube). It is used as the final amplifier in the M-3 & M-4 Systems or as intermediate amplifier in the M-101, M-1 & M-2 Systems preceding one, two or three #87 final Amplifiers. It mounts in the KS-7488 Cabinet and is part of the #1086 Amplifier (Assembly) which is arranged for either wall or rack mounting.

2. TYPES, CHARACTERISTICS, PARTS, ACCESSORIES, DRAWINGS AND PHOTOS

NOTE: REPLACE ALWAYS WITH APPARATUS CODE NO. NOT IN PARENTHESES ( ).

TYPE (Chassis only)	(A-86-A & B-86-A)	(A-86-A & C-86-A)	86-C & 86-E
DATE AVAILABLE	10-34 1-35	10-34 1-35	6-35 11-37
GAIN - Maximum	99 db	87 db	99 db
Normal Strapping Strap Per	ASL-8367	ASL-8568	ASL-8579
OUTPUT at 500-5000 cyc. (Max.) at 200 cycles (Max.)	15 Watts (34 db)	15 Watts (27 db)	15 Watts (24 db) 10 Watts (22 db)
NOISE LEVEL (Unweighted)	-50 db average, based on 78 db db Gain (0 db = 0.006 Watt)		
IMPEDANCE - Input	200 ohm (Nominal)		
Output	For 3.5 ohm to 7.5 ohm Load use 6 ohm tap (2.6 ohm) For 7.5 ohm to 15 ohm Load use 12 ohm tap (5.2 ohm)		
VACUUM TUBES - Amplifier Rectifier	1st, 2nd & 3rd Stage: 1, 262-A (ea.) - 4th Stage: 2, 300-A (P-P) Assembly A-165594, Detail 1-A, less A-165593, Detail 3, Base.		
VS-1 Shield, 1st Stage	285-H in 86-E, 261-B in other Amplifiers		
OUTPUT TRANSFORMER (71)	159-B (166-A)		159-B
POWER TRANSFORMER (74)	357-A (332-B) in 86-A & A-86-A (D-96970) in B-86-A & C-86-A		357-A (D-96970) in 86-A & A-86-A 86-C; 359-E in 86-E
POWER SUPPLY - Volts Cycles	Shield for Vertical Disc & PA Inputs - D-37846		105-125 60 Cycles ±5% for 86-A & A-86-A 50-60 Cycles ±5% for B-86-A & C-86-A 150: 86-A & A-86-A, 150: B-86-A & C-86-A 2 Amp. Fusetron
Watts (Maximum) External Fusing			150
FURNISHES MAXIMUM UN-FILTERED PEG and/or PLATE SUPPLY OF -	0.005 A @ 400V between Terminals #7(+) & #8(-) of M-13-B Cord 0.0075A @ 150V between Terminals #8(+) & #9(-) of M-13-B Cord 0.0105A @ 85V between Terminals #9(+) & #1(-) of M-13-B Cord		
SUPPLIES AG FILAMENT	10V AC (1 Ampere Max.)		
DIMENSIONS	8-1/2" Hx16-3/4" Wx10-1/2" D		
WEIGHT	35 lbs.		37 lbs.
AMBIENT TEMPERATURE	1100 F. (Max.)		
EQUALIZATION - In Ampl. Outside Ampl.	ASP-8693 Equal. Pts. TA-7304 App. Unit TA-7311 Type App. U. D-96996 Retardation Coil ASP-8523 Equal. Pts. ASP-8715 Equal. Pts.		ASP-8693 Equal. Pts. TA-7311 Type App. U. TA-7304 type Equal. Coil ASP-8523 Equal. Pts. ASP-8715 Equal. Pts.
ACCESSORIES: (See E.B. "AMPLIFIERS (ASSEMBLY) & SETS - 1086 TYPE", File 4.03) (See Dwg. ASR-4413 & ASO-6343, AMPL. 1086 TYPE, File 4.03)			
Cabinet	KS-7488		
Plate Meter (0-150% Scale)	TA-4176 (TA-4164)		
Front Connections	M-3-AB (3-Conductor)		
Other Connections	M-13-B (13-Conductor)		
Filters (Apparatus Unit)	714-A (90V DC) or 716-A (200V DC) D-99960		
SCHEMATIC	ASO-6340 for 86-A Type & 86-C ASR-4512 for 86-B Type ASR-4513 for 86-E Type		ASR-8615 for 86-E ASR-4560 for 86-E
WIRING	#9806, #983, #984, #86-#87 Amplifier Systems		
PHOTOS			

NOTE: The 86-B Amplifier (Gray; "PA" Model) differs from the 86-A, C & E Types as follows: 96 db Max. Gain; Output works into 500 or 8 ohm load; 45 db variable gain potentiometer in meter panel; 60 db fixed gain potentiometer under chassis. Has external "On-Off" Switch. 1086-B Ampl. (Assem.) consists of 86-B Amplifier; M-3-AD & M-13-C Cord; KS-7526 Bradleymeter; and KS-7535 Meter.

1. PAGES - PAGE 1 ISSUE #11  
Electrical Research Products Inc. OPERATING DEPT. - EQUIPMENT DIV. DATED 11/19/37

3.1 Power Transformer (74) Connections are made, per the amplifier schematic, for the average line voltage during operating hours.

3.2 Gain Setting - TSL is strapped for gain as required (usually 20 db below max. gain), per the "Gain Strapping Chart", immediately after unpacking, and the "Gain Strapping Chart" is made out and pasted on the front cover of the amplifier chassis. Important - TSL should not, under any circumstances, be strapped for maximum gain. A minimum of 10 db attenuation below maximum gain is necessary, and 20 db is preferable.

3.3 M-3-AB and M-13-B Cords are connected to T82, and the amplifier placed on the shelf of the KS-7488 Cabinet and the terminal strips of the two cords screwed to the bottom of the cabinet. External connections are made per the systems drawings.

3.4 Vacuum Tubes are inserted in the sockets per the markings on the amplifier. The second stage 262-A Tube should NOT be installed when the second stage is strapped out.

4. OPERATION (Advise projectionist 2nd tube is removed if 2nd stage is strapped out.)  
4.1 The #86 Amplifier is placed in operation by pressing the power switch to "ON". Ordinarily, the chassis power switch is left "ON" and the amplifier started and shut down by means of the main amplifier power switch.

4.2 Plate Current of Each Tube and Current to 714-A or 716-A Apparatus Unit (Filter) is indicated successively in percentage of normal on Meter (M1) by rotating switch (D1) from position #1 to #8. Check reading in each position with table on amplifier schematic.

5. MAINTENANCE (Schematic & Wiring Diagram Labels are on inside and outside of cover.)  
5.1 The two cords and their soldered connections should be checked periodically to see that they are reliably connected and in good condition. The vacuum tubes and external high voltage supply circuits should be checked periodically and all tube shields should be in their proper place, particularly the VS-1 shield over the first tube. The base of the VS-1 shield should make good electrical contact with the chassis.

5.2 357-A (D-96970) Power Transformer (74) and 197-A Retard Coil (12) - Intermittent buzzing, cracking or sputtering noises in the amplifier, may be caused by intermittent grounding of the coil to the case of either or both of these items because of the small clearance and loss of compound between the core and top of this case. This condition may be overcome by locking the core and case together mechanically and electrically as follows: Drill and tap a hole through the center of the top of the case (end opposite terminals) and 1/4" into the core for a #4, #6 or #8 screw, preferably #4. Lock the core tightly to the case with a round head screw and lock washer.

5.3 261-B Input Transformer - In case of no sound or intermittent noises, the windings of this item should be checked for open circuit or poor internal connections, taking special precautions to prevent magnetization of the core.

6. EQUALIZATION - MICROPHONIC  
6.1 The ASP-8693 Equalization Parts (E.B. "Systems, M-86 Type, Tuning-Up Procedure, File 4.385) are used, for high end equalization, with 86 type Amplifier Microphonic Systems, except with D-49-C P.E.C. Amplifiers.

7. UNDERWRITERS' APPROVAL - The 86-A, A-86-A, B-86-A, C-86-A and 86-C Amplifiers, when a part of the 1086-A Amplifier (Assembly) are listed as approved under the Underwriters Laboratories File E-5852-A (see reprint of card, E.B. File 7.8). The 86-E Amplifier has been approved by the Underwriters Laboratories and reprints of the card will be distributed shortly. The 1086-A Amplifier is also listed in the Underwriters' Laboratories "List of Inspected Electrical Appliances" indexed under "Sound Recording and Reproducing Equipment" of the Western Electric Co.

1. PAGES - PAGE 1 ISSUE #11  
Electrical Research Products Inc. OPERATING DEPT. - EQUIPMENT DIV. DATED 11/19/37

## WESTERN ELECTRIC

4.03

## MIRROPHONIC SYSTEMS

AMPLIFIER, 86 TYPE  
ADDENDUM 1EQUIPMENT BULLETIN

1. Intermittent Buzzing, Crackling, or Sputtering Noises, in 86 Type Amplifier Systems, may be caused by intermittent grounding of the core to the case of the 357-A (D-96970) Power Transformer (T4) and/or 197-A Retard Coil (I2), because of the small clearance and loss of compound between the core and the top of the case.

1.1 This condition may be overcome by electrically and mechanically locking the core and the case together as outlined in Section 2.

2. The locking of the core and the case of the 357-A (D-96970) Power Transformer and the 197-A Retard Coil should be done, as follows, when the noise condition outlined in Section 1 occurs.

Drill and tap a hole through the center of the top of the case (end opposite terminals) and into the core for 1/4", for a #4, #6 or #8 screw, preferably #4, then lock the core tightly to the case with a #4, #6 or #8 Roundhead Machine Screw, using a lockwasher between the case and the screwhead to insure good electrical contact and to prevent loosening of the screw. (#43 (.089") Drill for #4; #33, (.113") for #6, #29 (.136") for #8 screw.)

NOTE: A self-tapping steel screw may be used; if available.

3. Several cases have been reported where the 86 Type Amplifier was received at an installation with the 261-B Input Transformer having open windings.

In case of no sound or intermittent noises the windings of the 261-B Transformer should be checked for open circuit or poor internal connections, taking special precautions to prevent magnetization of the core.

1 Page - Page 1

Issue 1, August 18, 1937

Electrical Research Products Inc.

Operating Dept. - Equipment Planning Div.

4.03  
AMPLIFIERS, 86-TYPE  
ADDENDUM 2

EQUIPMENT BULLETIN1. PURPOSE

1.1 To provide information on the installation of the AQ-1030 Equalizer in 86-type Amplifiers.

2. ASSOCIATED DRAWINGS

ASL-14290 - File 4.64  
ASL-14175 - File 4.03, E. B. Amplifiers, 49-type

3. EQUIPMENT REQUIRED

3.1 One set of AP-1100 Modification Parts, consisting of:

1 - AQ-1030 Equalizer, less Det. 5, including as loose parts:

1 - Det. 7 Mounting Bracket  
1 - BT-1/2 - 20,000 ohm Resistor R3 or R-4  
1 - .01 Mfd. Condenser C-3  
1 - .0005 Mfd. Condenser  
1 - .0015 Mfd. Condenser  
1 - .0025 Mfd. Condenser  
1 - .2 Mfd. Condenser, C-1 or C-4  
1 - Length KS-7135 Cordage, 26" long  
1 - 8-32 x 5/32" R.H. Brass Machine Screw  
1 - 6-32 x 1/2" R.H. Brass Machine Screw

4. INSTALLATION PROCEDURE

(a) Replace equalizer leads with KS-7133 Cordage as follows:

White for green  
Black for red  
Shield for yellow

(b) Attach equalizer to the Det. 7 Bracket with the #8-32

4 Pages - Page 1 Electrical Research Products Inc. Issue 1  
Foreign Department March 29, 1940  
Technical Section

## EQUIPMENT BULLETIN

- x 5/32" screw furnished.
- (c) Remove 7311-type Apparatus Unit or other equalization from the circuit.
- (d) Where only one 714 or 716-type Apparatus Unit is installed, mount the equalizer bracket on the floor of the KS-7483 Housing, using the 6-32 x 1/2" screw furnished, and the nearer left-hand, tapped hole provided in the cabinet for a second apparatus unit.
- (e) Where the presence of a second apparatus unit prevents mounting the equalizer to the floor of the housing, it should be mounted on the top of the left-hand apparatus unit over the front left-hand corner by the screw holding the apparatus unit in place.
- (f) Strap amplifier as follows:  
2-3; 1-2 or 4; 5-6; 9-8, 10, 11 or 12; 13-14; 15-16; 17-16 or 18.  
Do not strap 7-8 or 7-16.
- (g) Bring KS Cordage up to 86 Amplifier and feed cordage along inside of terminal strip mounting bracket under the front three terminal lugs. Strip insulation and fasten shield of cordage to underside of ground terminal #4. Twist black and white leads together and connect white lead to terminal 7 of attenuation strip. Connect black lead to terminal 8. (Note: Make the unshielded ends of the black and white leads, at both ends of KS-7133 Cordage, as short as possible.)
- (h) Orient equalizer unit for minimum hum and tighten all screws.

## 5. ELECTRICAL RESULTS

- 5.1 Before proceeding with equalization, the system should

Issue 1

March 29, 1940

4 Pages - Page 2

## EQUIPMENT BULLETIN

be made to meet the normal transmission test requirements. After equalization, the variations from normal based on the corrections for the added equipment should again fall within limits.

NOTE: Before attempting to adjust the final setting on the H.F. end of the equalizer, the flutter content of the reproducer set should be brought within limits specified under E.B. "TA-7421 Flutter Bridge," File 4.61. If considerable flutter is present, it may affect materially the H.F. equalization selected as best.

- 5.11 The maximum high frequency equalization has been generally satisfactory for 15-type Horns. If desired, it may be reduced by substituting a 1 megohm for the .5 megohm resistor in R<sub>1</sub> position of the 49-type Amplifier. It may be further lowered by the insertion of the resistance condenser combination (R<sub>3</sub>, C<sub>3</sub>) furnished with the equalizer and installed as shown in Dwg. ASL-14290 (File 4.64, Testing Procedures). This change also raises slightly the low end response from 500 c.p.s. down.

- 5.12 The position of the H.F. peak and the H.F. cut-off region may be varied by changing values of C<sub>2</sub> condenser in the equalizer with condensers supplied to obtain curves as shown in Dwg. ASL-14290. It should be pointed out that if C<sub>3</sub> and R<sub>3</sub> are used, C<sub>2</sub> variation still affects the cut-off but has practically no effect on the location of the peak.

- 5.13 Three methods are available for reducing the I.F. response of the equalizer; namely, introducing C<sub>4</sub> or R<sub>4</sub> or increasing C<sub>1</sub> and introducing R<sub>4</sub>. These methods produce different effects in the 150 to 300 c.p.s. range for a given effect at 40 - 70 c.p.s. Increasing C<sub>1</sub> without using R<sub>4</sub> is not recommended.

4 Pages - Page 3

Issue 1

March 29, 1940

4.03  
AMPLIFIERS, 86-TYPE  
ADDENDUM 2

EQUIPMENT BULLETIN

5.2 Where 62-type Amplifiers are installed, it will not be necessary to modify them.

5.3 Where D-49-C Amplifiers are installed they should be modified to B-49-OT Amplifiers per E.B. "49-type Amplifiers, Addendum 3," File 4.03.

6. MERCHANDISING

6.1 Where 62-type Amplifiers are installed, order -

- 1 - Set AP-1100 Modification Parts

6.2 Where D-49-C Amplifiers are installed, order -

- 1 - Set AP-1100 Modification Parts
- 2 - Aerovox Type 484 1 MF. Condensers with spaghetti tubing.

7. CODING

7.1 The new coding of amplifiers converted by this equalization shall be the original coding with the letter "Q" added. For example, the 86-C becomes the 86-CQ.

Issue 1 Electrical Research Products Inc. Pages - Page 4  
March 29, 1940 Foreign Department  
Technical Section

4.03  
ASL-8768-1 AMPLIFIERS A-86-A,  
C-86-A - GAIN SETTING CHART.



FOR A-86-A AND C-86-A AMPLIFIERS

DB	GAIN SETTING			LINE VOLTS	T <sub>H</sub> PRI. CONN.	INSPECTOR	DATE
	TERMINAL STRAPPING ON TS <sub>1</sub> (SEE ASO-6340)						
(1)	87	1-2, 2-3, 5-6, 8-9, 13-14, 15-16, 16-17					
	82	1-4, 2-3, 5-6, 8-9, 13-14, 15-16, 16-17					
	77	1-2, 2-3, 5-6, 9-10, 13-14, 15-16, 16-17					
	72	1-4, 2-3, 5-6, 9-10, 13-14, 15-16, 16-17					
(2)	67	1-2, 2-3, 5-6, 9-11, 13-14, 15-16, 16-17					
	62	1-4, 2-3, 5-6, 9-11, 13-14, 15-16, 16-17					
	57	1-2, 2-3, 5-6, 9-11, 13-14, 15-16, 17-18					
	52	1-4, 2-3, 5-6, 9-11, 13-14, 15-16, 17-18					

FOR A-86-A AND C-86-A AMPLIFIERS

DB	GAIN SETTING			LINE VOLTS	T <sub>H</sub> PRI. CONN.	INSPECTOR	DATE
	TERMINAL STRAPPING ON TS <sub>1</sub> (SEE ASO-6340)						
(1)	87	1-2, 2-3, 5-6, 8-9, 13-14, 15-16, 16-17					
	82	1-4, 2-3, 5-6, 8-9, 13-14, 15-16, 16-17					
	77	1-2, 2-3, 5-6, 9-10, 13-14, 15-16, 16-17					
	72	1-4, 2-3, 5-6, 9-10, 13-14, 15-16, 16-17					
(2)	67	1-2, 2-3, 5-6, 9-11, 13-14, 15-16, 16-17					
	62	1-4, 2-3, 5-6, 9-11, 13-14, 15-16, 16-17					
	57	1-2, 2-3, 5-6, 9-11, 13-14, 15-16, 17-18					
	52	1-4, 2-3, 5-6, 9-11, 13-14, 15-16, 17-18					

- (1) Terminal strapping of amplifiers as received.
- (2) Recommended terminal strapping.

NOTE: After adjusting the gain of the amplifier, the installation inspector should out the proper label, sign and date it on the line showing the strapping as set, write in the line voltage and T<sub>H</sub> primary connections, and paste inside the front cover of the 86 type Amplifier.

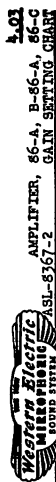

4.01  
86-C AMPLIFIER, B-66-A, B-66-C  
GAIN SETTING CHART

IMPORTANT NOTES:

86-C Amplifiers are now shipped with TSI strapped per (3) in the chart. This is the recommended gain setting for normal use.  
86-C Amplifiers were formerly shipped with TSI strapped per (2).  
86-A and the first 86-C Amplifiers were shipped with TSI strapped per (1).

The Installation Inspector should determine the gain setting of a specific amplifier from the chart below, and (after re-adjusting the gain, only if necessary) should cut out the chart, sign and date it on the line showing the strapping of TSI, write in the line voltage and % primary connections, and paste the chart inside the front cover.

FOR 86-A, B-66-A AND 86-C AMPLIFIERS

DB	GAIN SETTING		T <sub>1</sub> PRI. CONN.	INSPECTOR	DATE
	TERMINAL STRAPPING ON T <sub>1</sub>	LINE VOLTS			
(1) 99	1-2, 2-3, 5-6, 7-8, 8-9, 13-14, 15-16, 16-17				
94	1-4, 2-3, 5-6, 7-8, 8-9, 13-14, 15-16, 16-17				
89	1-2, 2-3, 5-6, 7-8, 9-10, 13-14, 15-16, 16-17				
84	1-4, 2-3, 5-6, 7-8, 9-10, 13-14, 15-16, 16-17				
(2) 79	1-2, 2-3, 5-6, 7-8, 9-11, 13-14, 15-16, 16-17				
78	1-2, 2-3, 5-6, 7-16, 9-11, 15-16, 16-17				
73	1-4, 2-3, 5-6, 7-16, 9-11, 15-16, 16-17				
68	1-2, 2-3, 5-6, 7-16, 9-11, 15-16, 17-18				
63	1-4, 2-3, 5-6, 7-16, 9-11, 15-16, 17-18				
57	1-4, 2-16, 7-8, 9-11, 15-16, 16-17				
47	1-4, 2-16, 7-8, 9-11, 15-16, 17-18				

FOR 86-A, B-66-A AND 86-C AMPLIFIERS

DB	GAIN SETTING		T <sub>1</sub> PRI. CONN.	INSPECTOR	DATE
	TERMINAL STRAPPING ON T <sub>1</sub>	LINE VOLTS			
(1) 99	1-2, 2-3, 5-6, 7-8, 8-9, 13-14, 15-16, 16-17				
94	1-4, 2-3, 5-6, 7-8, 8-9, 13-14, 15-16, 16-17				
89	1-2, 2-3, 5-6, 7-8, 9-10, 13-14, 15-16, 16-17				
84	1-4, 2-3, 5-6, 7-8, 9-10, 13-14, 15-16, 16-17				
(2) 79	1-2, 2-3, 5-6, 7-8, 9-11, 13-14, 15-16, 16-17				
78	1-2, 2-3, 5-6, 7-16, 9-11, 15-16, 16-17				
73	1-4, 2-3, 5-6, 7-16, 9-11, 15-16, 16-17				
68	1-2, 2-3, 5-6, 7-16, 9-11, 15-16, 17-18				
63	1-4, 2-3, 5-6, 7-16, 9-11, 15-16, 17-18				
57	1-4, 2-16, 7-8, 9-11, 15-16, 16-17				
47	1-4, 2-16, 7-8, 9-11, 15-16, 17-18				

1 PAGES - PAGE 1

Western Electric Products Inc.  
OPERATING DEPT. - EQUIPMENT DIV.

ISSUE #2  
DATED 4/2/57



4.01  
86-C AMPLIFIER, B-66-C  
GAIN SETTING CHART

IMPORTANT NOTES:

(a) Strapping of T<sub>1</sub> as shipped. Recommended when no 87 Amplifier is used.  
(b) Strapping of T<sub>1</sub> recommended when 87 Amplifier is added.  
(c) For use only in emergency if 1st stage is inoperative.

The Inspector should determine the gain strapping of a specific amplifier from the chart below, and (after re-adjusting the gain, only if necessary), should cut out the chart, sign and date it on the line showing the strapping of T<sub>1</sub>, write in the line voltage and % primary connections, and paste the chart inside the front cover.

FOR 86-C & 86-E AMPLIFIERS

STAGE OUT	ATTENUATION		GAIN DB	TERMINAL STRAPPING ON T <sub>1</sub>		INSPECTOR	DATE
	DB	IN STAGE					
None	5	None	99	1-2, 2-3, 5-6, 7-8, 8-9, 13-14, 15-16, 16-17			
		94	1-4, 2-3, 5-6, 7-8, 8-9, 13-14, 15-16, 16-17				
		89	1-2, 2-3, 5-6, 7-8, 9-10, 13-14, 15-16, 16-17				
		84	1-4, 2-3, 5-6, 7-8, 9-10, 13-14, 15-16, 16-17				
		79	1-2, 2-3, 5-6, 7-8, 9-11, 13-14, 15-16, 16-17				
2nd	10	None	78	1-2, 2-3, 5-6, 7-16, 9-11, 15-16, 16-17			(a)
		73	1-4, 2-3, 5-6, 7-16, 9-11, 15-16, 16-17			(b)	
		68	1-2, 2-3, 5-6, 7-16, 9-11, 15-16, 17-18				
1st & 2nd	15	None	63	1-4, 2-3, 5-6, 7-16, 9-11, 15-16, 17-18			(c)
		57	1-4, 2-16, 7-8, 9-11, 15-16, 16-17				
		47	1-4, 2-16, 7-8, 9-11, 15-16, 17-18				

Line Volts \_\_\_\_\_ T<sub>1</sub> Primary Connections \_\_\_\_\_

FOR 86-C & 86-E AMPLIFIERS

STAGE OUT	ATTENUATION		GAIN DB	TERMINAL STRAPPING ON T <sub>1</sub>		INSPECTOR	DATE
	DB	IN STAGE					
None	5	None	99	1-2, 2-3, 5-6, 7-8, 8-9, 13-14, 15-16, 16-17			
		94	1-4, 2-3, 5-6, 7-8, 8-9, 13-14, 15-16, 16-17				
		89	1-2, 2-3, 5-6, 7-8, 9-10, 13-14, 15-16, 16-17				
		84	1-4, 2-3, 5-6, 7-8, 9-10, 13-14, 15-16, 16-17				
		79	1-2, 2-3, 5-6, 7-8, 9-11, 13-14, 15-16, 16-17				
2nd	10	None	78	1-2, 2-3, 5-6, 7-16, 9-11, 15-16, 16-17			(a)
		73	1-4, 2-3, 5-6, 7-16, 9-11, 15-16, 16-17			(b)	
		68	1-2, 2-3, 5-6, 7-16, 9-11, 15-16, 17-18				
1st	15	None	63	1-4, 2-3, 5-6, 7-16, 9-11, 15-16, 17-18			(c)
		57	1-4, 2-16, 7-8, 9-11, 15-16, 16-17				
		47	1-4, 2-16, 7-8, 9-11, 15-16, 17-18				

Line Volts \_\_\_\_\_ T<sub>1</sub> Primary Connections \_\_\_\_\_

1 PAGES - PAGE 1

Western Electric Products Inc.  
OPERATING DEPT. - EQUIPMENT DIV.

ISSUE #1  
DATED 6/7/57